

A GUIDE
TO ROBOTICS
AND AUTOMATION

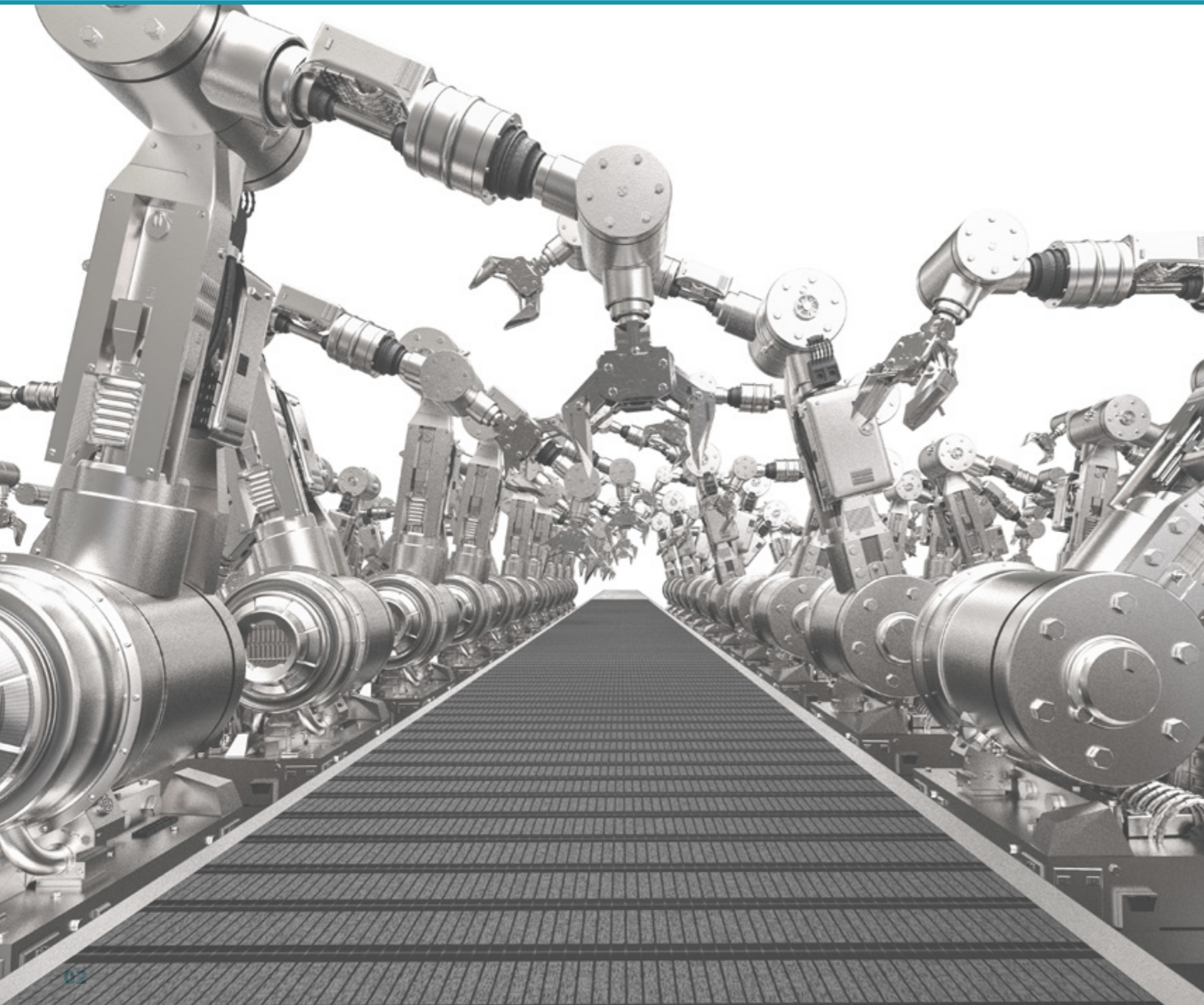

DISTRELEC

Terms & Conditions Apply



ROBOTICS FOREWORD

The world of robotics is changing rapidly, and the future of automation is only set to be more innovative and ground-breaking in the coming years. Robots are becoming part of our daily lives, and in the world of manufacturing, industrial robots have become the essential component to drive efficiencies; the epitome of a modern factory.

At Distrelec we are proud to supply businesses, laboratories, academic institutions and hobbyists with the components they need to produce the next big thing in automation.

We also strive to be knowledgeable and informative, keeping up with the latest developments. So we have created this robotics guide as a reference point for anyone who is working in or with, or is just interested by, robotics.

Steve Herd

Head of Category Management, Distrelec Group



Table of contents

06

THE HISTORY OF ROBOTICS

10

ROBOT TYPES AND APPLICATIONS

14

INDUSTRIAL ROBOTS

22

BEYOND MANUFACTURING –
ROBOTS AND THE SUPPLY CHAIN

26

MAKING (AND KEEPING)
THE CONNECTION

34

SEEING, HEARING,
TOUCHING, MOVING

42

ROBOT POWER AND MOVEMENT

50

COMPUTATIONAL OPTIONS
FOR ROBOTICS

56

SOFTWARE FOR ROBOTICS

60

AI IN ROBOTICS

68

EFFECTORS

72

THE FUTURE OF
MANUFACTURING AND MRO

78

WHAT DOES THE FUTURE HOLD
FOR ROBOTICS?



The History of Robotics

Robotics has its roots way back in ancient mythology, when the first 'metal man', Talos, was gifted by Zeus to Europa in ancient Greece, and gear-driven mechanisms were created. But it has come a long way since then. Pre-18th-century inventions and advancements in automation included appliances and musical instruments powered by water, wind and steam. In the 1700s toys and novelties were created that moved by themselves using systems of weights and gears.

Jump forward another century and you'll find the first inventions that involve automation to make work easier, such as Joseph-Marie Jacquard's machine that printed designs onto cloth, or Zadoc Dederick's 'Steam Man', which pulled a cart.

In 1913 the first conveyer belt assembly line was installed by Henry Ford, and in 1920 the word 'robot' was first coined by Karel Čapek. In 1928 the first humanoid robot that could move its hands and head went on display in London, and by 1929 Makoto Nishimura had created a robot that had facial expressions. In just a few years robots that could walk were being shown, and more inventions to speed up work were introduced. In 1942 the DeVilbiss Company designed a paint-spraying robot that could work much faster than a human. In 1950 Alan Turing proposed tests to determine if machines could think for themselves.

The world's first robotic arm was created in 1963 and was quickly followed by multi-jointed arms, and robotic arms controlled by computers. By 1970 we were seeing robots that could detect their own surroundings and react accordingly. And, at the same time in Japan, the first android robot was launched that could walk, grip, transport objects, sense objects and communicate.

Major advancements in movement and walking robots started in the 1970s. KUKA built the first industrial robot with six electromechanical axes, and in 1973 WABOT-1 was created. It was the first full-scale humanoid robot with full control of its limbs, vision and conversation.

The 1980s saw robots with more legs and a greater degree of freedom, and Honda began humanoid research and



























development. In 1989 MIT created a six-legged robot controlled by four microprocessors, 22 sensors and 12 servomotors.

In the 1990s, robotics really took off: from RoboTuna, which explored the oceans, to advances in healthcare with the CyberKnife – a radiosurgery-performing robot, designed to operate on tumours. Robots even went into space. NASA launched its Pathfinder robot, which landed on Mars, ready to explore the Red Planet and send brand new information back to Earth.

The 21st century has seen so many new and amazing innovations in robotics and automation. In 2000 the United Nations estimated that there were over 742,000 industrial robots being used around the world. In 2006 Cornell University revealed its Starfish robot, a four-legged robot capable of self-modelling that could learn to walk after being damaged. In 2011 Robonaut 2 was launched on Space Shuttle mission STS-133 – the first humanoid robot in space – and the next year Mars Rover Curiosity landed and began exploring, sending detailed analysis back to us about the Red Planet's structure.

In more recent years Ekso, the world's first exoskeleton, was released, which enables paralysed people to walk again. In 2015 Nadine, the most human-like robot we've seen, was created by the Nanyang Technological University. And in 2017 the first robot was granted Saudi Arabian citizenship: 'her' name is Sophia.

So looking back, we've come a long way, and it's surprising to see just how early humans decided to create things that could function on their own. And who knows where we will end up? Self-driving cars are coming closer to being a reality, and super-accurate robotic tools are already being used in hospitals around the world. It's going to be interesting to see what's added to the timeline in the coming years.

- | | | | | | |
|-----------------------|-------------------------------------------------------------------------------------|----------------------------------------------------------------------------------------------------------------------------------------|-------------|---------------------------------------------------------------------------------------|----------------------------------------------------------------------------------------------------------------------|
| Ancient Greece |  | Zeus gives Europa a 'metal man', Talos, as a gift
Organs and clocks driven by water power were created | 1977 |  | The first <i>Star Wars</i> movie was released, depicting a galaxy shared with robots |
| AD 10–70 |  | Hero of Alexandria wrote a book called <i>Automata</i> and invented a wind-powered organ, animated statues, and the first steam engine | 1981 |  | First quadruped robot created by Shigeo Hirose |
| 1495 |  | Leonardo da Vinci designed the first humanoid robot | 1990 |  | iRobot Corporation founded |
| 1645 |  | The first calculator, the Pascaline, was invented | 1996 |  | Honda revealed its first humanoid robot, P2 |
| 1913 |  | Henry Ford installed first conveyor belt assembly line | 1997 |  | NASA's Pathfinder robot landed on Mars |
| 1941–42 |  | Isaac Asimov wrote the Three Laws of Robotics | 1999 |  | Sony revealed AIBO, a robotic dog |
| 1942 |  | Paint-spraying robot designed by the DeVilbiss Company | 2000 |  | Honda showed its most advanced humanoid, ASIMO, which could run, walk, communicate and interact with its environment |
| 1950 |  | Alan Turing proposed the Turing Test to determine if a machine has the power to think for itself | 2001 |  | PackBot robots sent in after the World Trade Centre attack to search through debris |
| 1963 |  | First robotic arm | 2002 |  | iRobot released the first Roomba – a vacuuming robot for the home |
| 1969 |  | Man landed on the Moon | 2004 |  | The Mars rovers Spirit and Opportunity landed on Mars |
| 1970 |  | WABOT-1 created in Japan, able to walk, grip, transport objects, sense objects and communicate – the first android robot | 2004 |  | Epsom released the smallest-known robot of the time |
| 1970 |  | KUKA built the first industrial robot with six electromechanical axes | 2012 |  | Mars rover Curiosity landed on the Red Planet |
| | | | 2013 |  | iRobot revealed its first robot doctor |
| | | | 2017 |  | A robot called Sophia was granted Saudi Arabian citizenship |

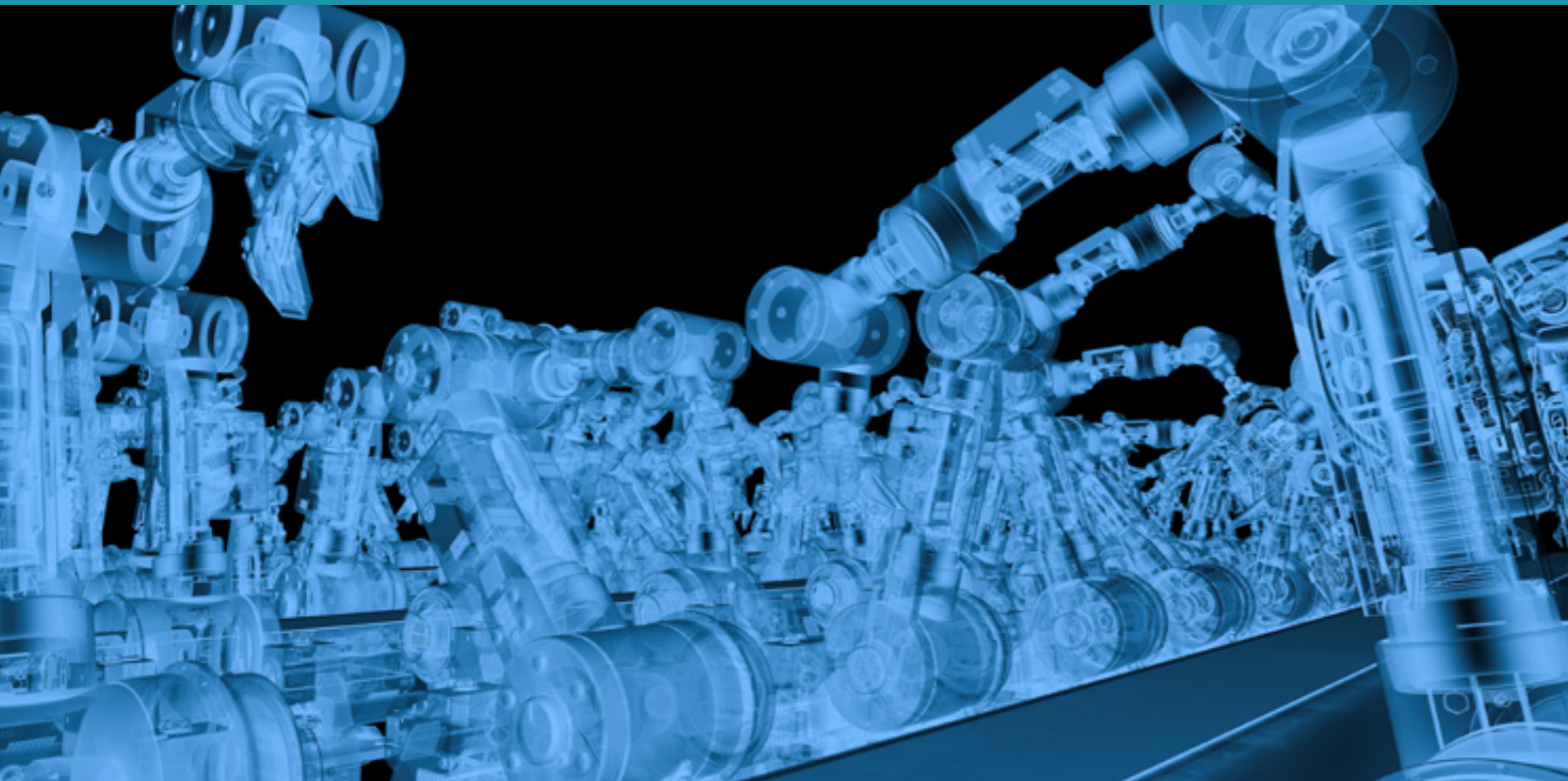

Robot Types and Applications

This category is for robots used in manufacturing, usually articulated arms developed for specific operations. They are automated, programmable and capable of movement on two or more axes. They are used for welding, material handling, painting, packaging and assembly lines.

The most common types of industrial robots are articulated, cartesian, cylindrical, polar, SCARA and delta. They all have their different uses in the industrial sector.

INDUSTRIAL

These include connections internally within the robotics platform, to the control system, to networked sensors and to other robotic systems.

Articulated: feature rotary joints and can range from two joints to over 10 joint structures.

Cartesian: also known as gantry or rectilinear robots. They have three linear joints, and usually a 'wrist' to allow for rotational movement.

Cylindrical: features at least one rotary joint at the base and one prismatic joint to connect the links. They work in a cylindrical-shape work area.

Polar: also known as spherical robots. The arm is connected to the base with a twisting joint and a combination of two rotary joints and one linear joint. They work in a spherical area.

SCARA: mainly used in assembly lines. Primarily cylindrical, they feature two parallel joints that provide compliance along one plane.

Delta: spider-like robots, built from jointed parallelograms connected to one base. Capable of delicate and precise movements, they are often found in food, medical and electronic industries.

DOMESTIC, HOUSEHOLD AND SERVICE

Mainly created for household chores, domestic robots come in many shapes and sizes. There are carpet cleaning robots that tend to be round in shape and low to the ground, and the same is true of floor washing robots. There are more complicated gutter and pipe cleaning robots with brushes and wipers that rotate around a spherical body.



Other types include a hot-air robot to iron shirts, self-cleaning cat litter boxes, kitchen robots that can make or cook food, and security robots that can patrol properties, alerting owners to the presence of intruders.

Outside the house there are garden robots, including robot mowers that work like the indoor vacuum bots, but mow the lawn instead. Robots are also used to clean swimming pools, removing debris and cleaning tiles. There are also magnetic autonomous window cleaning robots that spray cleaning solution onto microfibre pads and gently wash windows.

Service robots include those that are made for social interaction and help those who need assistance. For example robots that keep elderly people company when they are alone for long periods of time, and can be programmed to remind them to take their medication and get up and walk around, as well as other useful functions.

Home telepresence robots can move around in a remote location and enable people to communicate with each other via speaker, camera and microphone. These are particularly useful for healthcare workers checking on their patients.

MEDICAL

Used in medical sciences, medical robots include surgical robots, rehabilitation robots, biorobots, telepresence robots, pharmacy robots and disinfection robots.

With a robot being able to work more exactly and precisely than a human hand, surgical robots are starting to be used in operating theatres all over the world. Robots have been used in all areas of surgery, including neurosurgery and ophthalmology. The CyberKnife robotic radiosurgery system uses image guidance and computer-controlled robotics to treat tumours in the body.

Rehabilitation robots are used for helping people who have lost the use of part or all of their body. They can be passive or active robots, meaning that either the user or the robot makes the movements, but either way the user benefits. Using robots means that every time a movement is made, it is done in exactly the same way, ensuring consistency.

Biorobotics covers robots that have been designed to emulate or simulate biological organisms. It covers the creation of life from non-living matter. It is in its infancy as a field, and is sometimes referred to as synthetic biology or bionanotechnology.

Telepresence robots, also referred to as teleoperation robots, allow off-site health carers to assist, diagnose and talk to patients when they cannot be there in person. They are controlled remotely by a person, in this case by a doctor in their office, and can be moved around a patient's home, assessing their living conditions and allowing the doctor to

talk to and look at the patient via speakers, microphones and cameras.

Pharmaceutical robots enable medicines to be handled and distributed with absolute accuracy. Already used in some hospitals, these robots can work 24 hours a day and can be programmed to dispense medicines safely. This leads to fewer cases of cross-contamination and a faster dispensary.

Disinfection robots are relatively new to medicine. They have the capability to disinfect an entire room in just a few minutes using ultraviolet light technology. One of the advantages of this type of robot is that humans don't have to go into hazardous rooms where there is a risk of infection. The robot can simply get to work and clean, reducing the spread of infectious diseases and bacteria.

MILITARY AND SPACE

A number of forces around the world now use robots as part of their operations, including helping with transport, search and rescue, defence and attack. Robots have been in use in the military since World War II, when remote-controlled tanks were first used by Soviet forces. Today there are developments in autonomous vehicles that can cross rough terrain, and weapons systems that autonomously load and fire ballistics. Military weapons are not allowed to be fully autonomous and have to have human input to adhere to the Geneva Convention governing the laws of war.

Drones, autonomous fighter jets and bombers are being further developed to keep humans out of harm's way in combat. Robotic aircraft could be programmed to ascend quicker, and perform movements that wouldn't be possible if a human was on board.

Bomb disposal robots, such as Dragon Runner used by the British Military, allow operators to analyse explosive devices without getting too close. The robots are remote controlled, highly manoeuvrable, and can dig around suspicious devices,

as well as pick them up and move them. Dragon Runner has the ability to plant small charges to disrupt devices, and can cut wires. The robot sends video via live feed to the operator, so no one has to enter buildings or unsafe terrains.

In space, robots are used as exploration devices as well as extra arms outside the International Space Station. The rover Curiosity landed on Mars in 2012 and is a mobile laboratory. It travels across the surface of the planet, collecting and analysing samples, and sending the information back to Earth. It can travel over obstacles and cover around 200 metres a day, powered by a radioisotope thermoelectric generator.

Robotic arms have been installed on the outside of the ISS to deploy, capture and repair satellites, position astronauts, maintain equipment and move cargo.

Another robot found on the ISS is Dextre, a robot handyman used for tasks outside the space station, including the routine tasks done by astronauts during risky spacewalks. Dextre has two arms that are over three metres long, with seven joints and grippers that work like the components in a pocket knife. The grippers have been given sensors that give it an almost human-like sense of touch, and there are tools, camera, lights and a connector to provide power and data as the robot uses electronic equipment or conducts experiments.

ENTERTAINMENT, HOBBY AND COMPETITION

This category covers toys, and robots that you create yourself, either for fun or for competition. There are so many different types, from robo-dogs suitable for children, to robots that fight against each other in gladiator-style arenas. There are also humanoid robots, such as Sony's QRIO and WowWee's Robosapien, that are capable of walking, voice recognition and some level of interaction.



The lightweight Dragon Runner Bomb Disposal Robot is easy to transport and can be deployed in many different terrains (Crown copyright 2012)

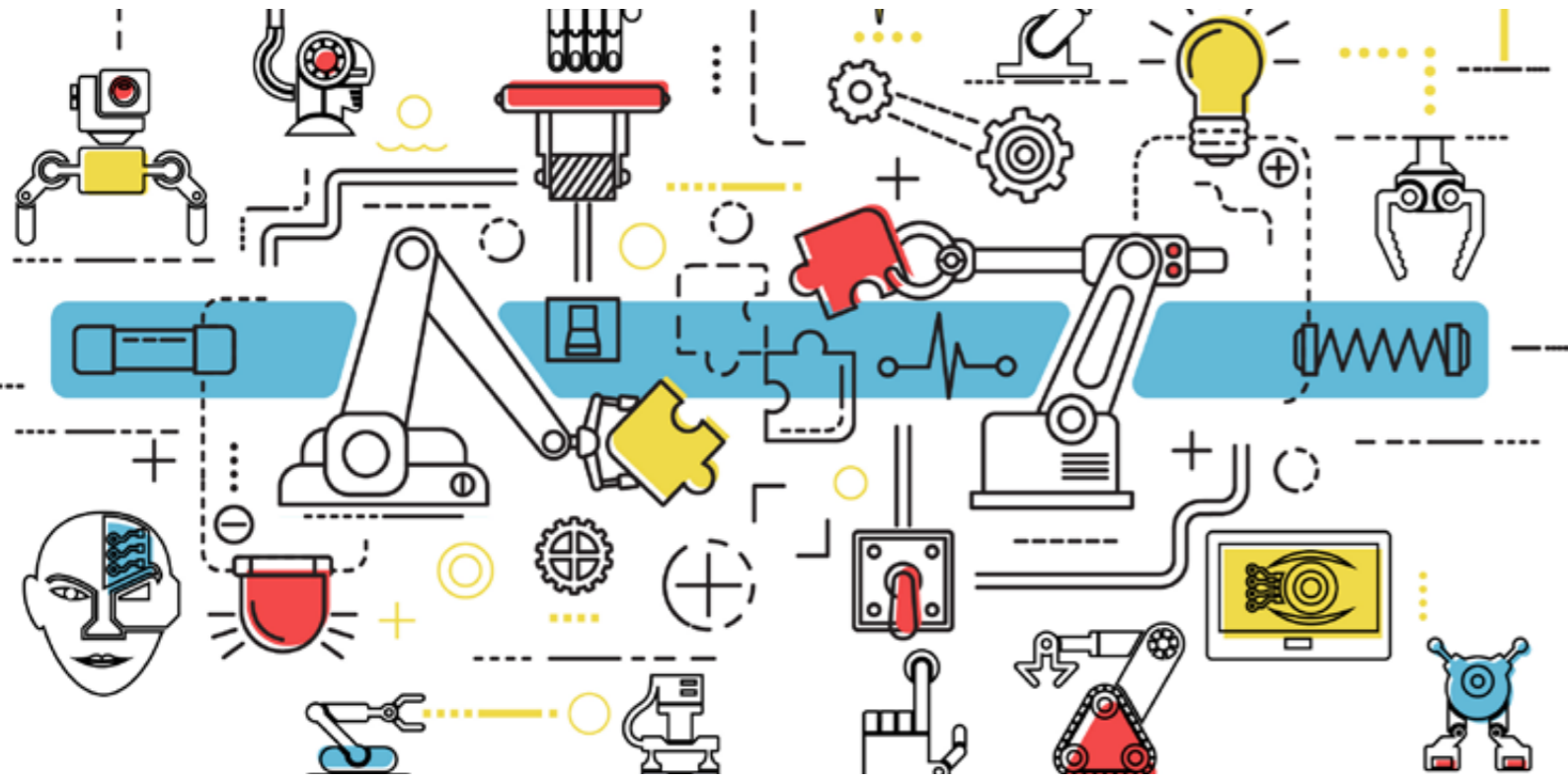

Industrial Robots

This section discusses industrial robots in more depth, looking at the worldwide market drivers, different robot types, typical applications, basics of programming and safety considerations.

MARKET TRENDS

Industrial robots are driving competitive advantage across manufacturing, enabling companies to respond to the challenges of faster business cycles, greater variety in customer demand, competitive pressure and the challenge of reducing emissions. The falling costs of industrial robots has

lowered capital investment requirements, increasing adoption across all industrial sectors.

Estimates predict that the number of industrial robots operating worldwide will rise from 1,828,000 units at the end of 2016 to 3,053,000 by 2020, with the bulk of this growth in Asian factories, particularly in China, where it is forecast that over 950,000 units will be deployed.

China, the Republic of Korea, Japan, the United States and Germany accounted for 74% of industrial robot production in 2016, and Figure 1 shows the growth in the supply of industrial robots by industry over the period 2014 to 2016.

Collaboration – inter-robot, and between robots and humans – is increasing in importance, driven by a trend towards low-volume production runs with a high component mix, requiring more variability and more human intervention.

Collaborative automation allows people and robots to each contribute their unique strengths – with people providing insight and improvisation, and robots offering speed and repetition. ABB’s IRB 14000 series is a prime example of a new generation of collaborative robots, developed initially in 2015 for small parts assembly applications. The importance of collaboration is demonstrated by the recent venture between ABB and Kawasaki to develop the next generation of ‘cobots’.

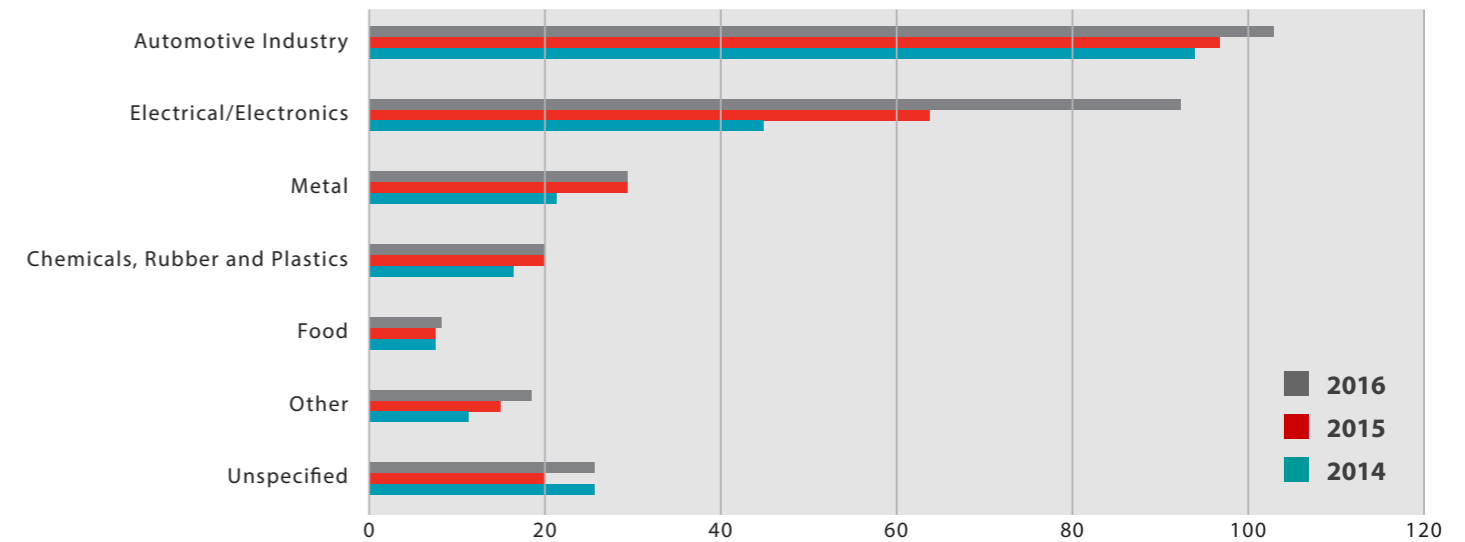

Figure 1: Overall, usage of industrial robots has increased year-on-year (Source: IRF 2017 Report)

TYPES OF INDUSTRIAL ROBOTS

Most industrial robots are classified as stationary robots, with a robotic arm moving above a stationary base. Stationary robots break down into six main types, shown in Table 1, with the most commonly used being articulated, SCARA, delta and cartesian coordinate robots.

Type	Description	Typical application
Cartesian/gantry	Operate within x-, y- and z-axes using linear guide rails	Pick-and-place work, sealant application, arc welding
Cylindrical	Rotary joint combined with prismatic joint. Movements occur within a cylindrical work envelope	Assembly operations, spot welding, machine tool handling
Spherical	Combined rotational joint, two rotary joints and a linear joint to achieve a spherical work envelope	Spot welding, die casting, gas and arc welding
SCARA	Compliant arm is cylindrical in design and comprised of two parallel joints providing compliance in one plane	Pick-and-place work, sealant application, assembly operations, machine tool handling
Articulated	Rotary joints connect the links in each arm; each joint is a different axis, providing an additional degree of freedom. Articulated robots have four or six axes	Assembly operations, die casting, gas and arc welding, paint application
Parallel or delta	Built from jointed parallelograms connected to a common base. Parallelograms move a single end-of-arm tooling in a dome-shaped envelope	Pick-and-place operations requiring precision

Table 1: Main types of industrial robot

Robots are also specified in terms of various operating parameters, as summarised in Table 2.

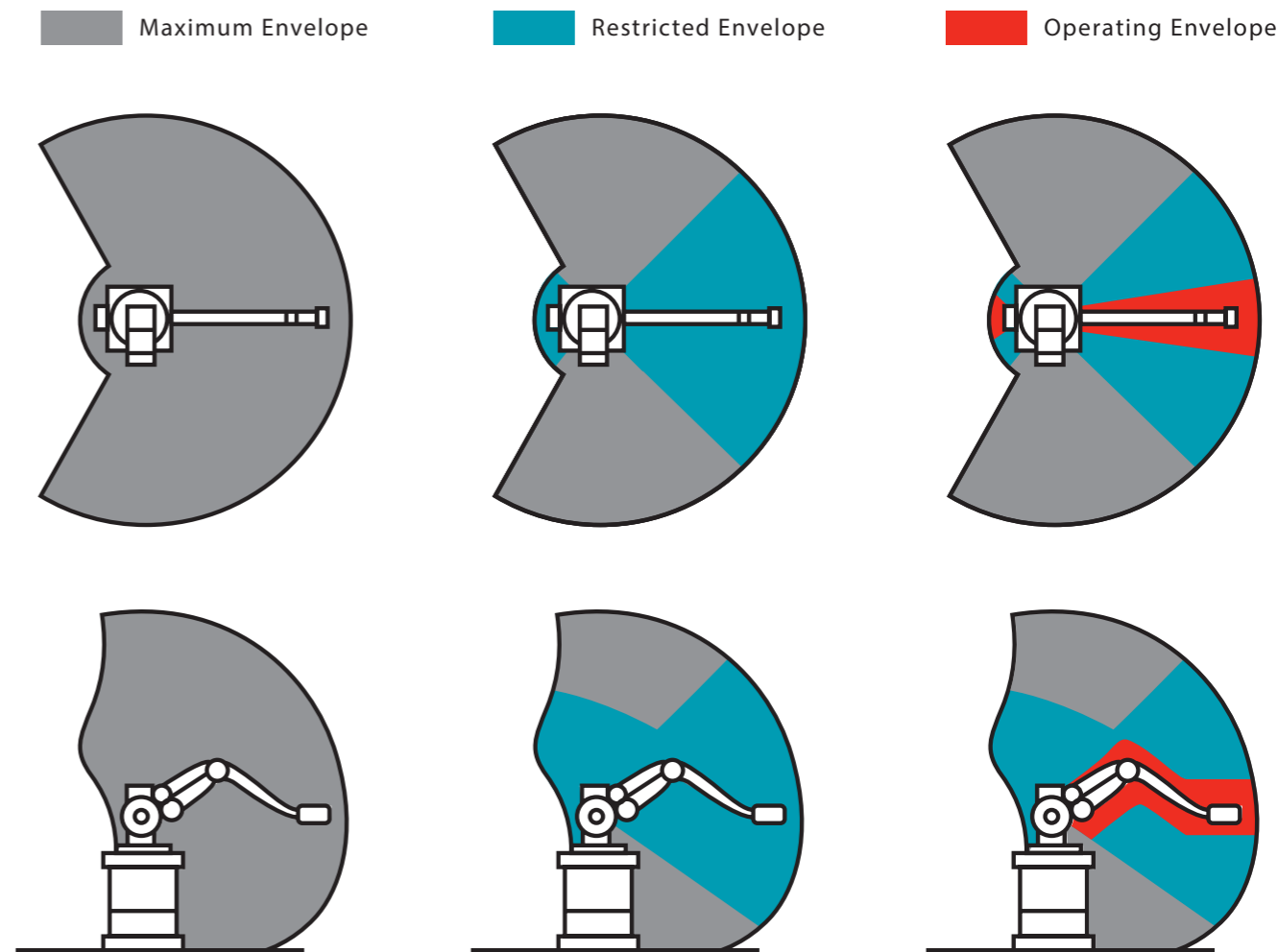

The working envelope needs to be considered for each robotic application

Parameter	Description
Number of axes/ degrees of freedom	Two axes are required to reach any point in a plane, three to reach any point in space. Three more axes (yaw, pitch and roll) are required to fully control the orientation of the end of the arm (the wrist)
Working envelope	The region of space a robot can reach
Kinematics	The arrangement of rigid members and joints in the robot, determining the robot's possible motions. Classes include articulated, cartesian, parallel and SCARA
Carrying capacity/ payload	How much weight a robot can lift
Speed	The speed at which the robot can position the end of its arm, defined in terms of the angular or linear speed of each axis or as a compound speed
Acceleration	How quickly an axis can accelerate. Since this is a limiting factor a robot may not be able to reach its specified maximum speed for movements over a short distance or a complex path requiring frequent changes of direction
Accuracy	The absolute position of the robot compared to the commanded position is a measure of accuracy. Accuracy can be improved with external sensing, e.g. vision systems or infrared. Accuracy can vary with speed and position within the working envelope and with payload (compliance)
Repeatability	If a position is taught into controller memory and each time the robot is sent there it returns to within 0.1 mm of that taught position, then the repeatability will be within 0.1 mm
Motion control	For applications such as simple pick-and-place assembly, the robot only needs to return repeatedly to a number of pre-taught positions. For applications such as welding and finishing, motion must be continuously controlled to follow a path in space, with controlled orientation and velocity
Power source	Examples include electric motors and hydraulic actuators
Drive	Some robots connect electric motors to the joints via gears, others connect the motor to the joint directly (direct drive). Smaller robot arms often use high-speed, low-torque DC motors, requiring high gearing ratios with the disadvantage of backlash
Compliance	The amount of angle or distance that a robot axis will move when a force is applied to it. When a robot goes to a position carrying its maximum payload it will be at a position slightly lower than when it is carrying no payload

Table 2: Operating parameters of industrial robots

EXAMPLE APPLICATIONS

Here we look at two examples of industrial robots which have been developed by their manufacturers to meet the specific needs of their intended application.

The IRB 5500 series by ABB

The IRB 5500 series by ABB is an articulated robot with six axes of movement, developed for spray painting on car assembly lines.

The IRB 5500 has three characteristics which make it suited to its chosen application:

- Large work envelope, removing the requirement to have two robots for paint application across a horizontal surface such as a car bonnet, which creates a 'stitching' effect in the centre. A single robot removes this quality control issue entirely.
- High acceleration: for sophisticated applications, such as welding and spray painting, motion must follow a path in space, with controlled orientation and velocity. If a robot slows down too much when reversing, excess paint will accumulate in those regions of the vehicle where the slow movement takes place.
- High payload, enabling closer integration of the processing equipment with the work surface, reducing waste.

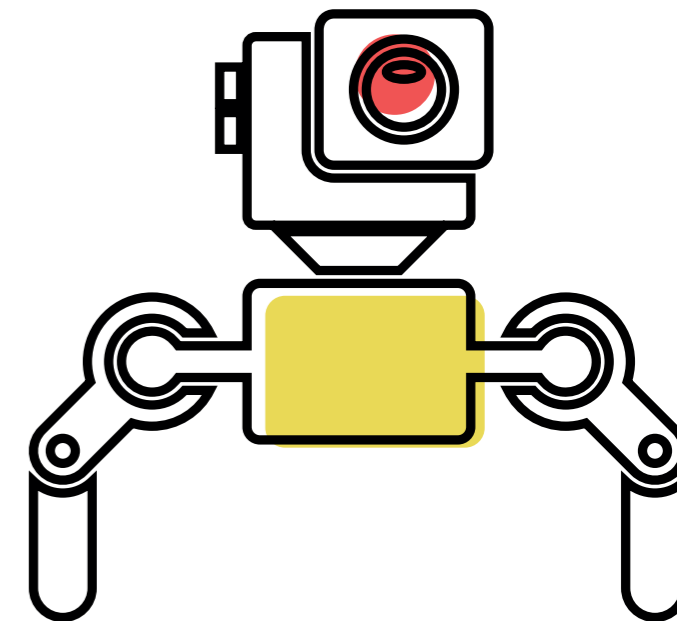
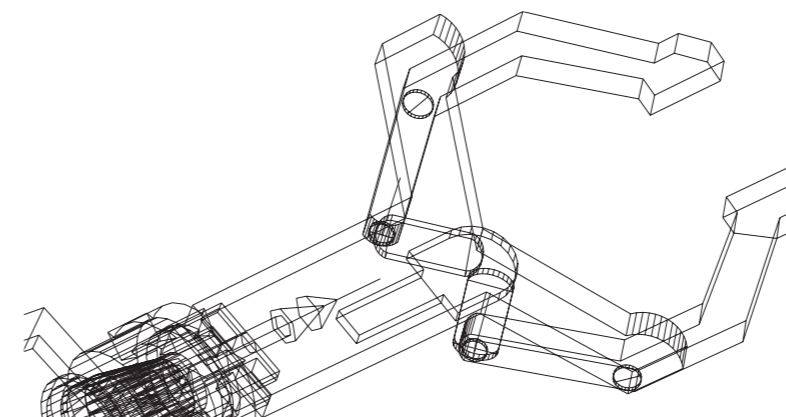

The Quattro 800 series by Omron

This is a parallel robot designed for high-speed manufacturing, packaging, material handling and assembly. With the actuators all located in the base, the arms can be made of a light composite material, resulting in moving parts with low inertia, allowing for very high-speed acceleration. Having all the arms connected to the end effector increases the robot's stiffness, but reduces the size of its working envelope.

The following characteristics of the Quattro lend themselves to the targeted applications:

- Speed – 10 m/s (vs 1m/s for IRB 5500)
- Repeatability – 0.1 mm (vs 0.15 for IRB 5500)
- Working envelope – operates within a 1300 mm cylindrical area suited to the size of food production lines

PROGRAMMING INDUSTRIAL ROBOTS

Programming a robot involves the establishment of a physical or geometrical relationship between the robot and the equipment or task to be serviced by the robot. In doing so it is necessary to control the robot manually and physically teach it the coordinate points within its working envelope.

There are three commonly used programming or teaching methods:

Lead-through programming or teaching

A handheld control and programming unit, or teach pendant, is used to manually send the robot to a desired position. It can also change to a low speed to enable careful positioning, or while testing through a new or modified routine. A large emergency stop button is usually included as a safety measure.

Walk-through programming or teaching

With the robot in 'safe mode' the user moves the robot by hand to the required positions and/or along a required path while the controlling software logs these positions in the controller memory. The program can later run the robot to these positions or along the taught path. This technique is popular for tasks such as paint spraying.

Offline programming or teaching

The robot and other machines or instruments in the workspace are mapped graphically, allowing the robot to be moved on screen and the process simulated. Simulators can thus create programs for a robot without depending on the physical operation of the robot arm, saving time during application design. Additionally, various 'what if' scenarios can be tried and tested before the system is activated, increasing operational safety levels.

A combination of methods will often be used. Programs created using lead-through or walk-through methods can be reviewed and refined using offline simulators. Operator control panels can also be used to switch programs, make adjustments within a program and also operate a host of peripheral devices that may be integrated within the same robotic system. A computer is often used to 'supervise' the robot and any peripherals, or to provide additional storage for access to numerous complex paths and routines.

ABB's SRP programming toolset for the IRB5500 enables lead-through programming using a simulated paint spray gun with the simulation and offline programming software, RobotStudio, being available for offline review and further development.

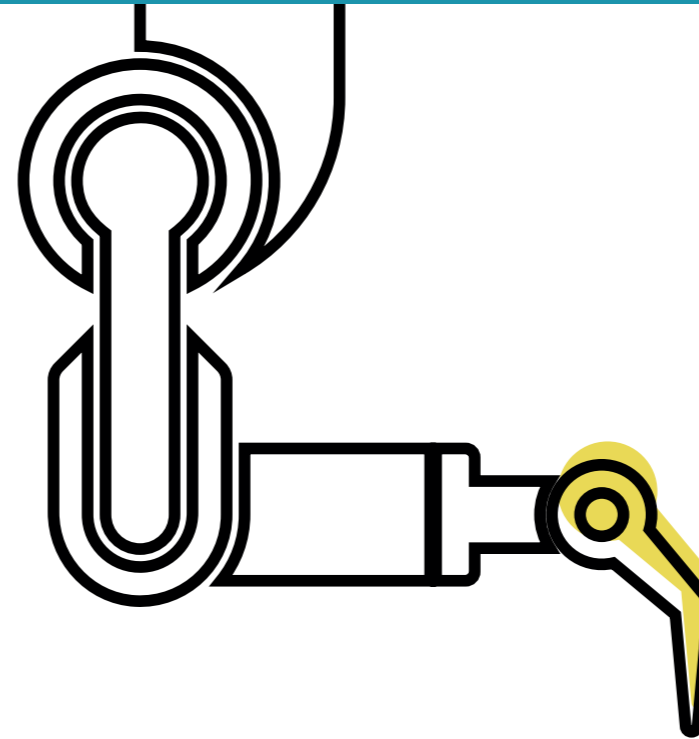
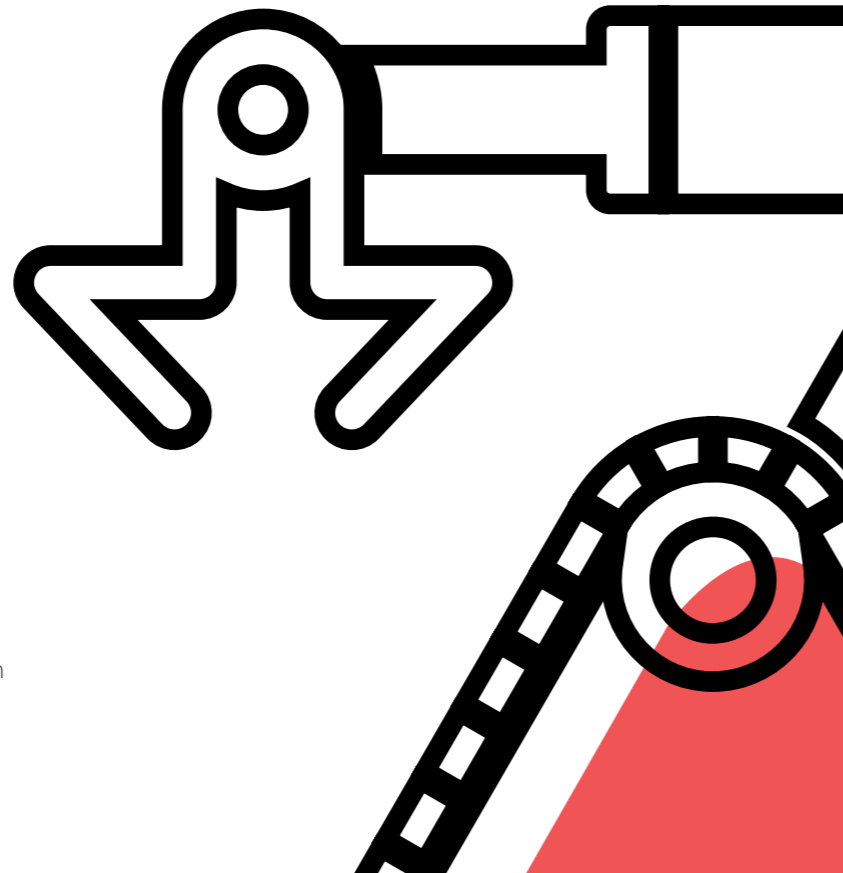

SAFETY CONSIDERATIONS AND SYSTEMS

Various safety concerns must be considered when implementing robotic production systems. Care must be taken to ensure separation of humans from the operating envelope of the robot, as the end effector is capable of rapid acceleration resulting in high forces. Physical barriers and locking systems should be deployed to prevent the operator or other personnel from entering the work zone while the robot is operational.

Programming a robot is potentially dangerous, as the operator must be in physical contact with the robot, so safety devices should be in operation, such as a teach mode where the speed of the robot is limited, along with emergency stop buttons. Sensors can also be integrated into the design of the robot to prevent excessive force or limit proximity to unexpected objects.

Additionally, the type of robot should be chosen to match the characteristics of the environment in which it will operate – e.g. care should be taken when deploying electric motors in environments where combustible materials or gases may be ignited by static or sparks.

CONCLUSION

This section has provided an overview of the different types of industrial robot that may be deployed, along with a description of how these robots and their characteristics are adapted for specific applications. Consideration has also been given to programming of robots as well as safety aspects, and two robots developed for two very different applications have been discussed.

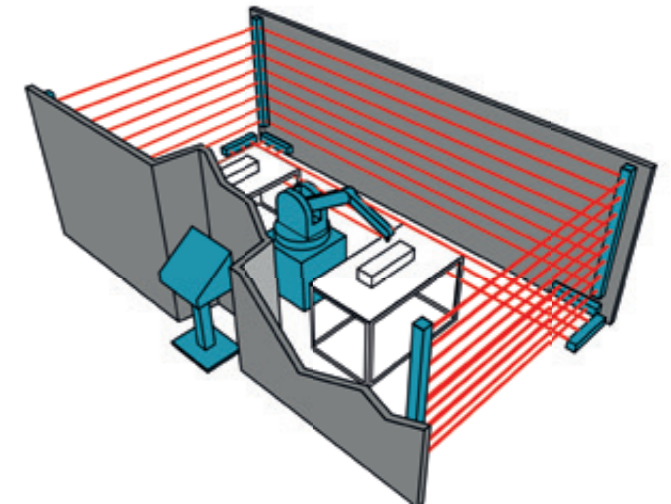

In addition to emergency stop buttons, light curtains protect human operators from accidental entry into a robot's working envelope

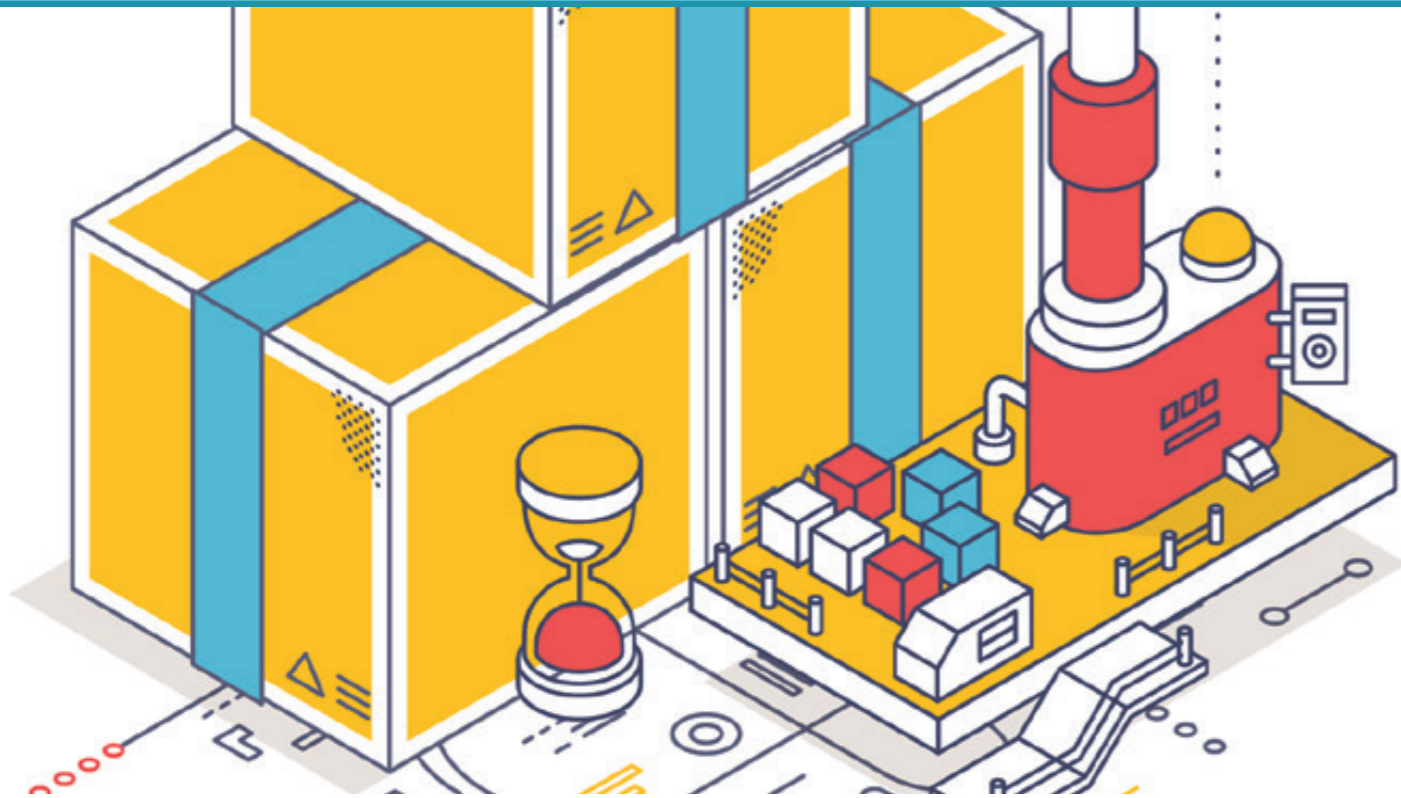

Beyond Manufacturing – Robots and the Supply Chain

How robotics can support faster, safer and more productive logistics.

While commonplace on the manufacturing side of the supply chain, to date robots have seen limited adoption in the logistics sector. A key reason for slow uptake has been the commercial viability of technology to address the complexities of the challenge – complexities that include handling a wide array of different parts in an almost infinite number of combinations, safety implications of humans and robots collaborating in the same space, and the prohibitive cost of hardware and computing power.

Now, however, the situation is changing and advanced robots are starting to enter our warehouses and sorting centres, even helping with 'final mile' delivery to the end customer. DHL, a company that is actively engaged in the deployment of advanced robotics, is well placed to consider the latest developments and how they will help to deliver logistics supply chains that are faster, safer and more productive.

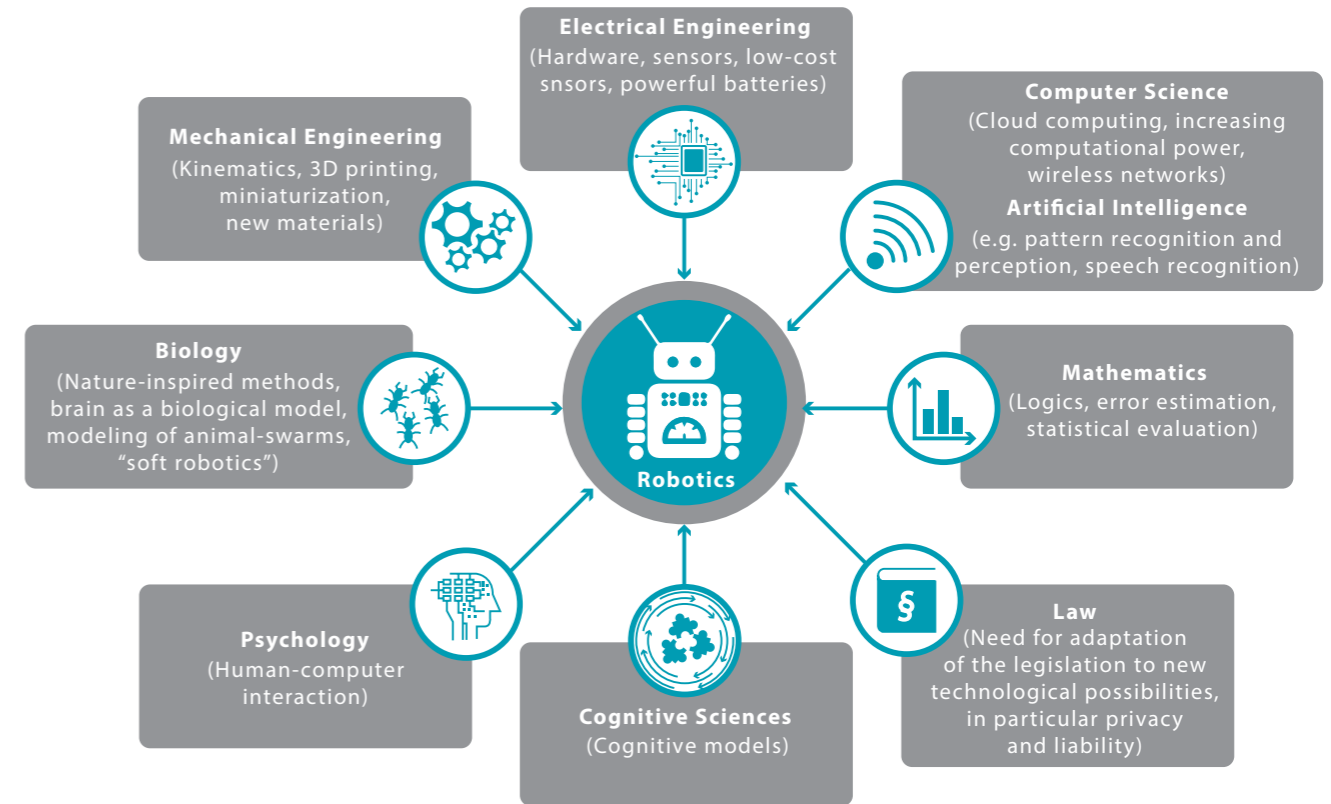

Advanced robotics is a complex, multi-faceted challenge

ROBOTICS IN LOGISTICS – THE TIME IS RIGHT

The main reason for the lack of logistics robots is that, until recently, robots have been simplistic – performing the same movements over and over again, albeit with a high degree of accuracy and precision. For many simple manufacturing processes, such as welding or transferring parts, these skills are all that is needed. Logistics, however, requires a robot with more versatility and ability.

Labour availability is a significant challenge for the logistics industry. More workers are needed due to the growth in e-commerce and the need to move from bulk pallet shipments to individual packages that are shipped to consumers. This drives more cost and labour per item sold. In the Western world, the challenge of finding and hiring labour is exacerbated by shrinking populations, which reduces the available workforce.

Given these challenges, robotics has moved from being 'nice to have' to being a necessity for the future of the logistics industry.

ENABLING TECHNOLOGIES

A robot that is effective in supporting logistics operations will need to have some form of 'eyes', 'hands', 'feet' and 'brain'. It will need eyes to see an object, hands to pick it up, feet so that it can move the object to another place, and a brain capable of coordinating all these tasks.

Creating 'eyes' requires more than just an image sensor or camera; sophisticated machine vision software is required to interpret the data. For example, when picking from a bin the robot has to identify a single part from many, even if the item is partially obscured. The robot then needs to plan how to move its arm and hand to pick the item up.

To address this challenge, Universal Robotics uses a Microsoft Kinect sensor and its Neocortex software to mimic the human brain. Using this approach, a robot is trained to pick up a specific item and this knowledge is then transferred to other robots.

Meanwhile Schunk designs and sells robotic grippers. Its latest hand follows nature, mimicking the human hand with five fingers, twenty joints and nine motors. Weighing only 1.3 kg, this robotic hand can pick up heavy tools with a 'power grip' or delicate electronics with a 'precision grip' – just like a human hand. Robotics that replicates human hands may be the key to giving robots the flexibility needed for the logistics world.

Enabling logistics robots to move around a warehouse, sorting centre or even a town requires advances in technology such as omnidirectional wheels that can move a robot in any direction without turning.

The all-essential robotic brain would need unprecedented computing power to replicate the human brain. As robots will be dedicated to a limited task set, the computing power can be reduced. Technology is moving in the direction of cloud processing where robots would transmit images to,

say, Google, allowing their powerful computers to identify an object and return information on how to pick it up.

NEAR-FUTURE LOGISTICS ROBOTS – SOME USE CASES

Containers are a very popular method for ocean shipping of goods from factories and, to save on transport costs, they often arrive stacked with goods from floor to ceiling – without pallets. As early as 2003, DHL developed a Parcel Robot that was capable of using a laser to scan the container contents and then unload the container onto a conveyer belt in an optimal sequence.

On the other hand, mobile piece-picking robots move to fixed shelves to retrieve goods. Fetch Robotics is one example where a primary robot ('Fetch') can extend its torso to reach items on high shelves and pass them to a second robot ('Freight') that holds a tote for the item. The Fetch robots operate in a single aisle, while the Freight robots are more agile, moving around the warehouse to where goods are located.

Co-packing robots, such as 'Baxter' from Rethink Robotics, work alongside humans to perform tasks such as unpacking

boxes, adding promotional labels and then re-packing the boxes. With spring-loaded joints and sensors to detect when it touches an object, Baxter is safe to operate with humans and is trained by grabbing an arm and leading it through a simple task.

SSI Schaefer's Robo-Pick uses an automated tote system to move goods to a stationary robot that identifies the required item, picks it and deposits it onto a conveyer belt. This system is claimed to be able to pick up to 2400 items per hour and works best with smaller items such as DVDs or pharmaceuticals. More sophisticated versions can place the picked item into a final shipping box.

The final frontier for logistics is taking the robot outside of the warehouse to perform the ultimate delivery steps to a home or business.

An early example of this comes from Starship Technologies, whose autonomous robot can carry two grocery bags arriving at an address at a precise time. Recipients can track progress on a mobile app and use the same app to unlock the robot and retrieve the goods.

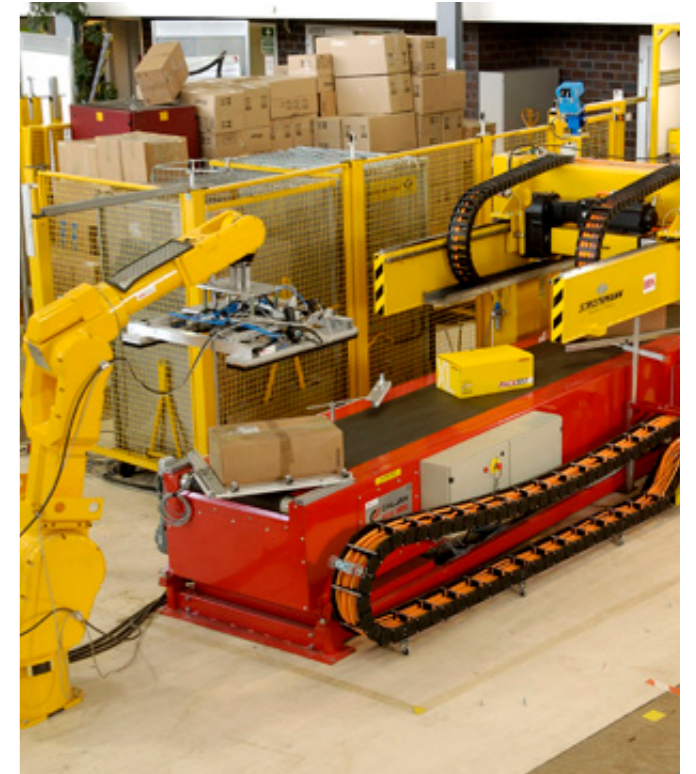

One of DHL's robots is capable of optimally loading a shipping box with packages (Source: DHL Express © 2018)

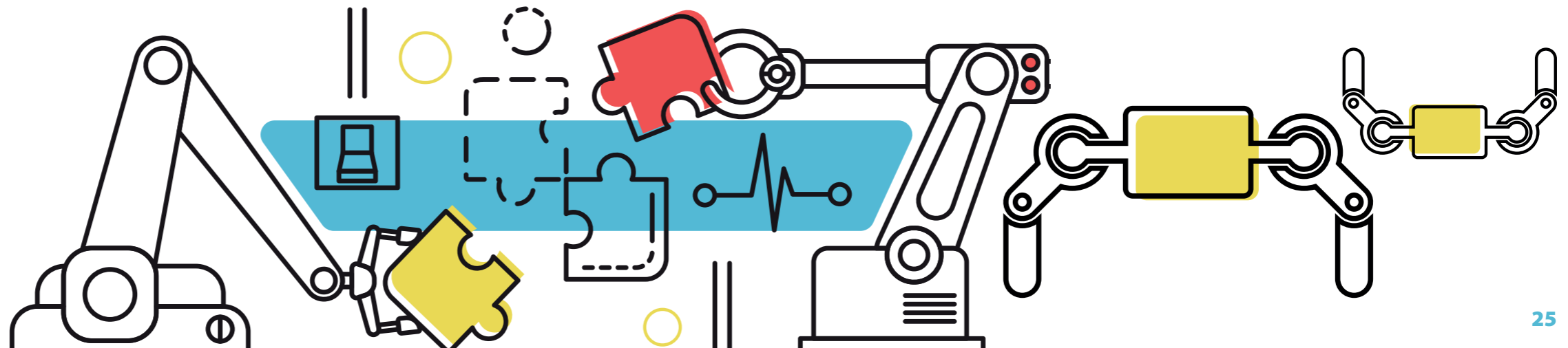



Making (and Keeping) the Connection

In any complex robotic or automated system, a large number of power, data and signal connections must be reliably made between multiple components and sub-systems.

INTERCONNECTION

With thousands of connections, implemented both wired and wirelessly, interconnections must be 100% reliable if the advantages of a long operating life and high efficiency are to realize the cost benefits robotic systems are designed to deliver.

The number of sub-systems that need interconnection is vast and they have many different characteristics. Examples

include low-power sensors, both internal and external to the robotics platform, that deliver signal levels in the millivolt range, as well as sophisticated robot hands or 'effectors', with a 'haptic' ability to sense and manipulate objects, and which require real-time data and video streams screened from sources of electromagnetic interference. In addition, connections may also need to deliver high currents in pulsed loads to motors, servos and other electromechanical devices.

Power, data and signal interconnections will often be in close proximity, requiring high-density connectors. Since they will often be routed through the same space or even the same connector there is the potential for electrical interference between systems.

The operating environment will also define the interconnection solution, as parts of the robotic platform could be moving in several axes each creating its own levels of shock and vibration. Other factors to be considered are temperature extremes, water, dust, a corrosive atmosphere, exposure to chemicals, and proximity to hazardous processes such as welding.

CHOOSING AN INTERCONNECTION SOLUTION

Connector options will include circular, rectangular multi-block, data connectors and terminal blocks. With the restrictions in space and a large number of connections, a good option is to use modular connectors that can be semi-customised with a combination of power, data and signal contacts. Manufacturers such as Harting, with its Han-Modular® series of products, allow unique connector configurations by selecting from a range of connector modules, hoods and housings. This approach reduces the overall number of connectors and the overall size of the solution without the need for a full custom connector design.

In robotics applications, there will be situations where parts of the system are moving relative to static parts of the system. This creates torsional stress on the connector and associated cabling, so consideration needs to be given to strain relief for the connector, the type of cable used and the routing of the cables throughout the system.

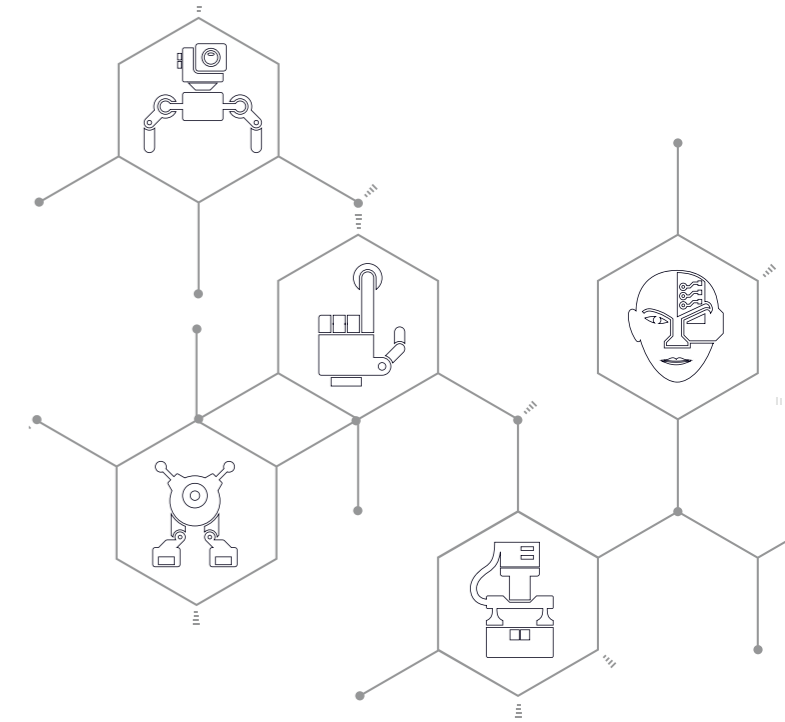

In some cases, parts of the robot will need to rotate, so slip-ring connectors are used to guarantee a high-integrity connection. These are electromechanical parts that solve the engineering problem of providing a reliable connection to a rotating object by transferring power or data through a metal or graphite brush that is kept in contact with a metal ring as it rotates. The electrical resistance is higher than in a static connector solution, but the moving parts can wear and oxidise over time.

Another solution to making contact with moving parts is the contactless Ariso connector series offered by TE Connectivity, which uses an inductive magnetic coupling to deliver power and data without a physical connection, and if necessary through water or oil.

Connectors can also be divided into locking and non-locking types, with locking typically achieved in circular connectors using a threaded coupler, and in rectangular connectors using locking arms.

Non-locking data connectors such as USB are well suited electrically to the transmission of high-speed data but are easily disconnected, and are not suited for harsher environments. Ruggedised versions such as those manufactured by Bulgin can be used that lock and provide protection against exposure to liquids and dust.

The design of the connector contacts is vital for long-term reliability and this is a likely point of failure in non-benign environments. Many connectors have a male-to-female contact arrangement, and the long-term reliability depends on the design of the connector contacts (material and plating) and whether they are lubricated. Bifurcated contact points which allow for redundant electrical paths are recommended in dirty environments.

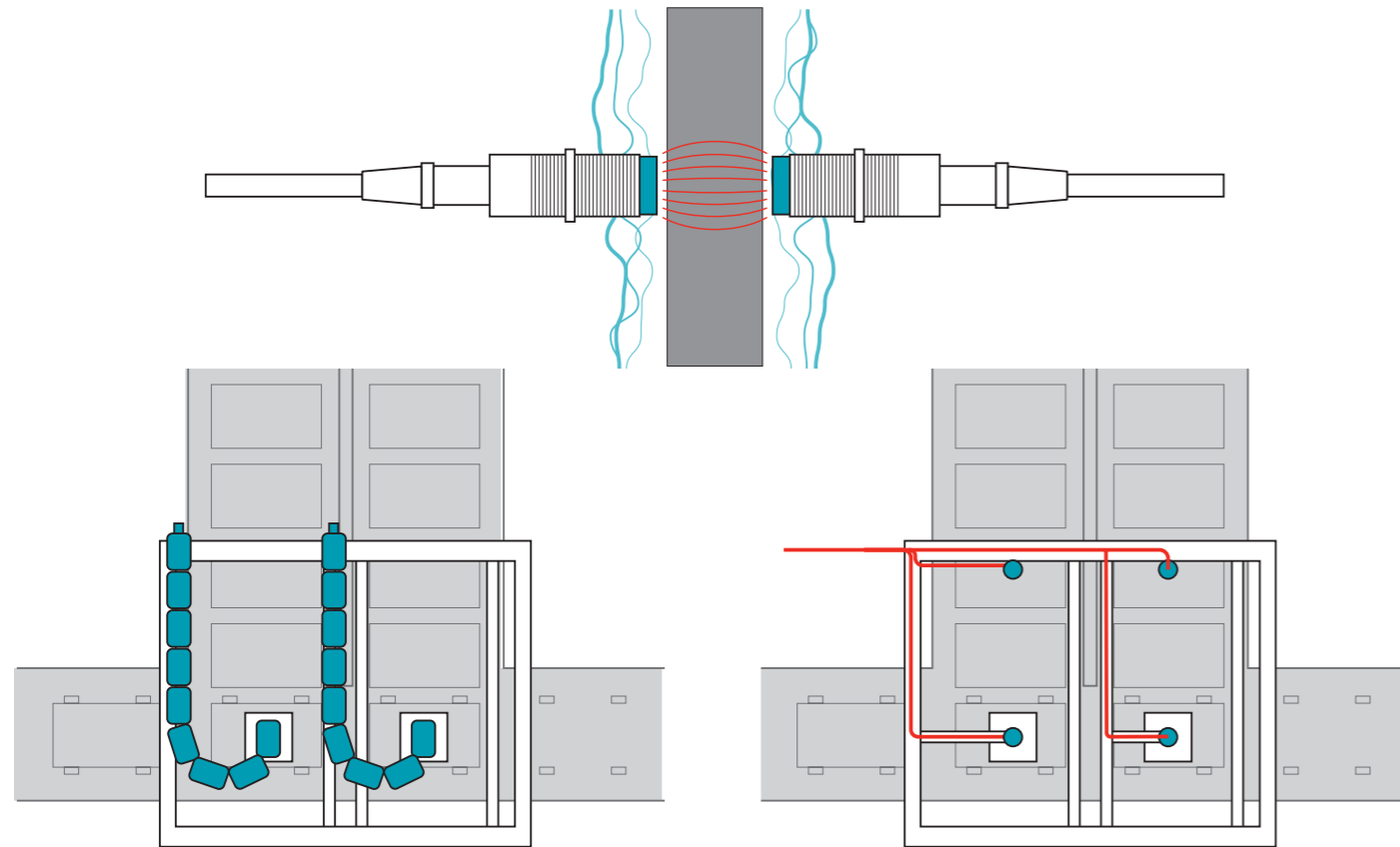

Cables and connectors can fail over time; contactless connectors can overcome these issues

NETWORKING CONNECTIVITY

Early robots used proprietary networking standards to connect controllers to remote components. In order to reduce costs and deployment times, it is preferable to make use of PCs equipped with off-the-shelf Ethernet networking hardware.

Many people understand the term 'Ethernet' to be the cable that connects their PC to the local area network (LAN) and the internet. In fact, this is only the physical part of the internet, which carries a series of communications protocols such as Transmission Control Protocol/Internet Protocol (TCP/IP) and other protocols that enable communications. This set-up suits consumer applications, but to control any complex process the network must provide three key elements: deterministic, real-time control; system-wide time synchronisation; and precise scheduling.

The IEEE 802.1 working group of the IEEE Standard Association has proposed draft standards to allow time-sensitive networking (TSN) to be conducted over standard Ethernet networks. The new project draft IEEE 802.1Q is aimed at delivering real-time networking for both audio and video applications as well as real-time control for industrial networking.

NETWORKING PROTOCOLS

A number of industrial networking protocols are available to organise the movement of data packages within the TCP/IP architecture.

Ethernet/IP, part of the Common Industrial Protocol (CIP) family (which includes ControlNet and DeviceNet) is an application layer that uses traditional Ethernet protocols including TCP/IP and is compatible with standard Ethernet hardware, meaning it can be easily implemented and should be future-proof. It works by organising data packets in such a way that real-time performance is possible over standard Ethernet hardware, which brings advantages in deployment time and cost. It is well supported by multiple vendors and is popular in the North American market, where it is often used with Rockwell Collins control systems.

Another market-leading standard is EtherCAT, which was created by German automation company Beckhoff in 2003. It focused on achieving a short cycle time, low jitter and low hardware costs. The protocol has been widely adopted by the semiconductor, display and solar panel manufacturing industries including Applied Materials, Lam Research and Brooks Automation, which has given it a significant user base and market share.

EtherCAT uses a principle called 'processing on the fly', which means messages are passed on before they are processed, resulting in high speed and efficiency. This approach is claimed to provide the most deterministic response of any of the Ethernet standard available.

EtherCAT uses an open-software approach combined with off-the-shelf Ethernet master controllers with customised EtherCAT slave controllers (ESCs). The ESCs contain proprietary application-specific integrated circuits (ASICs), field-programmable gate arrays (FPGA) and other microcontrollers programmed with licensed software. EtherCAT hardware is available from many manufacturers, who have made a fairly large investment in design and development. Consequently, they are more expensive than standard Ethernet components.

WIRELESS CONNECTIVITY

In many applications, the robotics systems will be mobile, for example autonomous vehicles or pallet-handling systems in a logistics environment.

It is also desirable in many systems, even if the robotics platform is static, for there to be only power connections made to the system and for the data traffic to the control system to be made wirelessly. This results in less cabling and also more flexibility when re-configuring factory layouts.

Wireless protocols for robotics and industrial automation are still in the early stages of adoption, but will be essential to fully realise a connected network of robots, sensors and measurement devices. When selecting a wireless protocol for industrial applications key criteria will be the required range, frequency and data rate.

Many common communication technologies are well established in all areas of industry; for example, Bluetooth

is often used to replace wired point-to-point connections, and for real-time applications Wi-Fi using protocols designed for industrial use can be deployed quickly, as they have low latency and do not require an external network operator. However, Wi-Fi has limitations such as having very few channels, which can interfere with each other, and it is sensitive to the EMI/RFI that is generated in industrial environments. 4G LTE (cellular) has the potential to enable communications over a range of many kilometres, and has high bandwidth and reasonable latency – but it requires a network operator, with each connected terminal requiring an individual SIM. It should be noted that this SIM requirement will not apply in future. One successful application hotspot is agricultural farm equipment, which uses 4G combined with GPS on large farms with 24/7 operation significantly improving machinery utilisation.

Other protocols that are suited to non-real-time applications such as the deployment of large-scale wireless sensor networks (WSNs) are based on the IEEE 802.15.4 technical standard and include WirelessHART, ZigBee and ISA100.11a.

Protocol	Data rate	Max range	Frequency
4G LTE	50 Mbps	Many km	2 to 8 GHz
5G	Est. 1 Gbps (TBD)	Many km	TBD
Bluetooth	1 Mbps	150 metres	2.4 GHz
IEEE 802.15.4	250 Kbps	75 metres	868/915/2450 MHz
Wi-Fi	1 Gbps	50 metres	2.4/5 GHz
WirelessHART	250 Kbps	225 metres	2.4 GHz
ZigBee	250 Kbps	75 metres	2.4 GHz

Table 1: Wireless protocol comparison

CLOUD ROBOTICS AND 5G

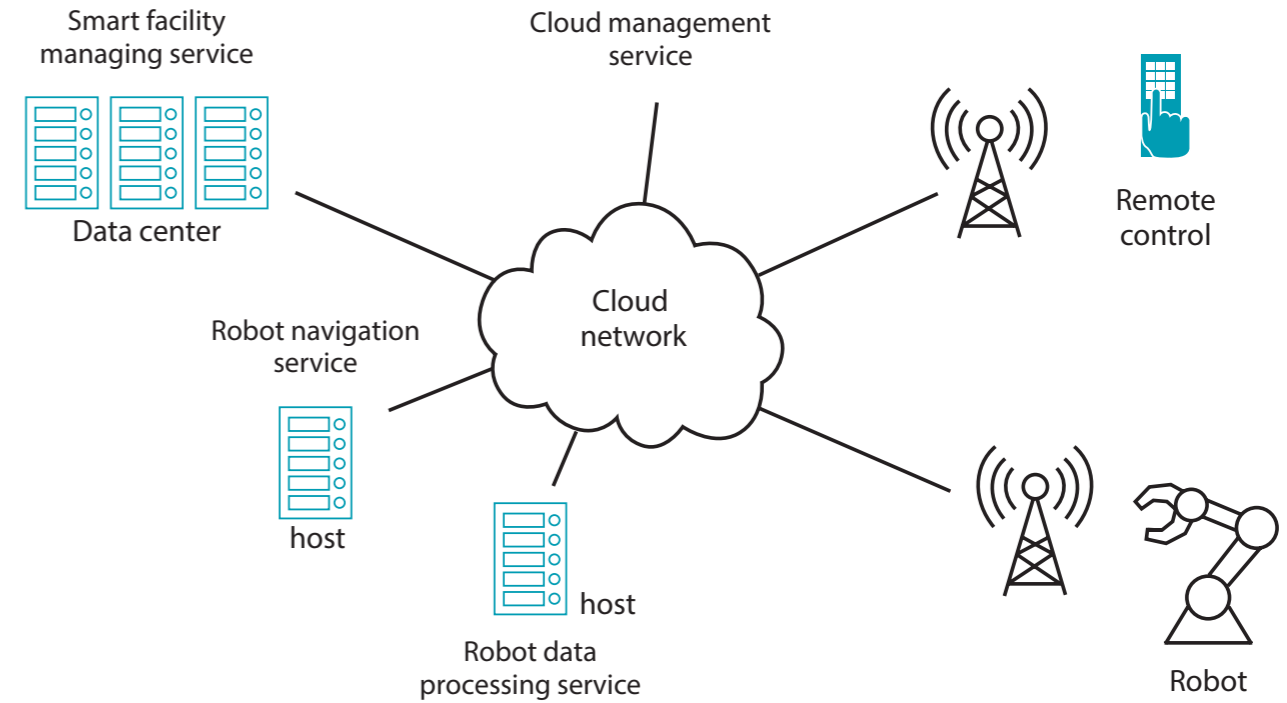

5G technology, with gigabit connectivity, may negate the need for other types of wireless networks

All of the wireless protocols discussed here are too slow to enable robotics to reach its full potential.

In order to fully realise mobile, autonomous robots that can manage real-time complex processes and make instant decisions the raw processing power would occupy more hardware real estate and consume more power than can economically and physically be incorporated into an industrial robot.

For robotics to reach the next level this processing will be done in the cloud and be driven by 5G networks. These

networks are not yet in existence, with mass rollouts likely to be in 2020, and the actual performance is not fully defined. With data rates that could be as high as 1 gigabit per second the robot will be connected via the cloud and a cloud management service to a number of other services, including remote control, data processing, navigation and facility management. In addition to the high data speed, a key benefit will be very low latency, making them suited to real-time applications.

SECURITY

With the increase in connected systems and with more open standards used in industrial environments, the risk of security breaches, both intentional and accidental, will increase. Networks will need encryption, devices will need to be authenticated and critical areas and infrastructure will need security control.

In March 2017 it was reported that security researchers successfully hijacked a 100 kg robotic arm manufactured by ABB by inserting a USB stick containing malicious code.

The robot, equipped with gripping claws, welding tools and laser capability, had serious potential to damage the manufacturing process and pose a danger to factory operators.

Robotic systems are some of the most complex in existence, operating in difficult and challenging environments.

In order to realise their full potential, the overall approach to their internal connections and connectivity to the wider network needs to be carefully considered during all phases of design and implementation.

KEY FACTORS TO CONSIDER



01

How many power, data and signal connections are needed for each sub-system? What are the electrical, EMI screening, space, weight and environmental considerations?



02

When choosing the interconnection solution consider the design of the connector contacts, whether a locking connector is required, whether dust or waterproofing is a requirement, and whether a modular connector with a combination of power, data and signal contacts would be a space-saving option.



03

To control a complex process the networking connectivity solution must support real-time control, time synchronisation and precise scheduling. Ethernet/IP and EtherCAT are both popular protocols to consider.



04

Industrial networking protocols combined with TCP/IP architecture and off-the-shelf Ethernet networking hardware provide a cost-effective solution for robotics and industrial control.



05

A number of wireless connectivity protocols can be deployed for robotics applications, depending on the application, required data rate, range, frequency and environment.



06

New-generation 5G networks being rolled out in 2020 with high data speeds and low latency will make cloud robotics a reality. Future mobile, autonomous robot platforms will be powered by real-time processing performed in cloud-based servers.



07

Industrial networks and systems are at risk of security breaches, so the encryption of hardware, networks and the surrounding infrastructure is an essential part of the system design.



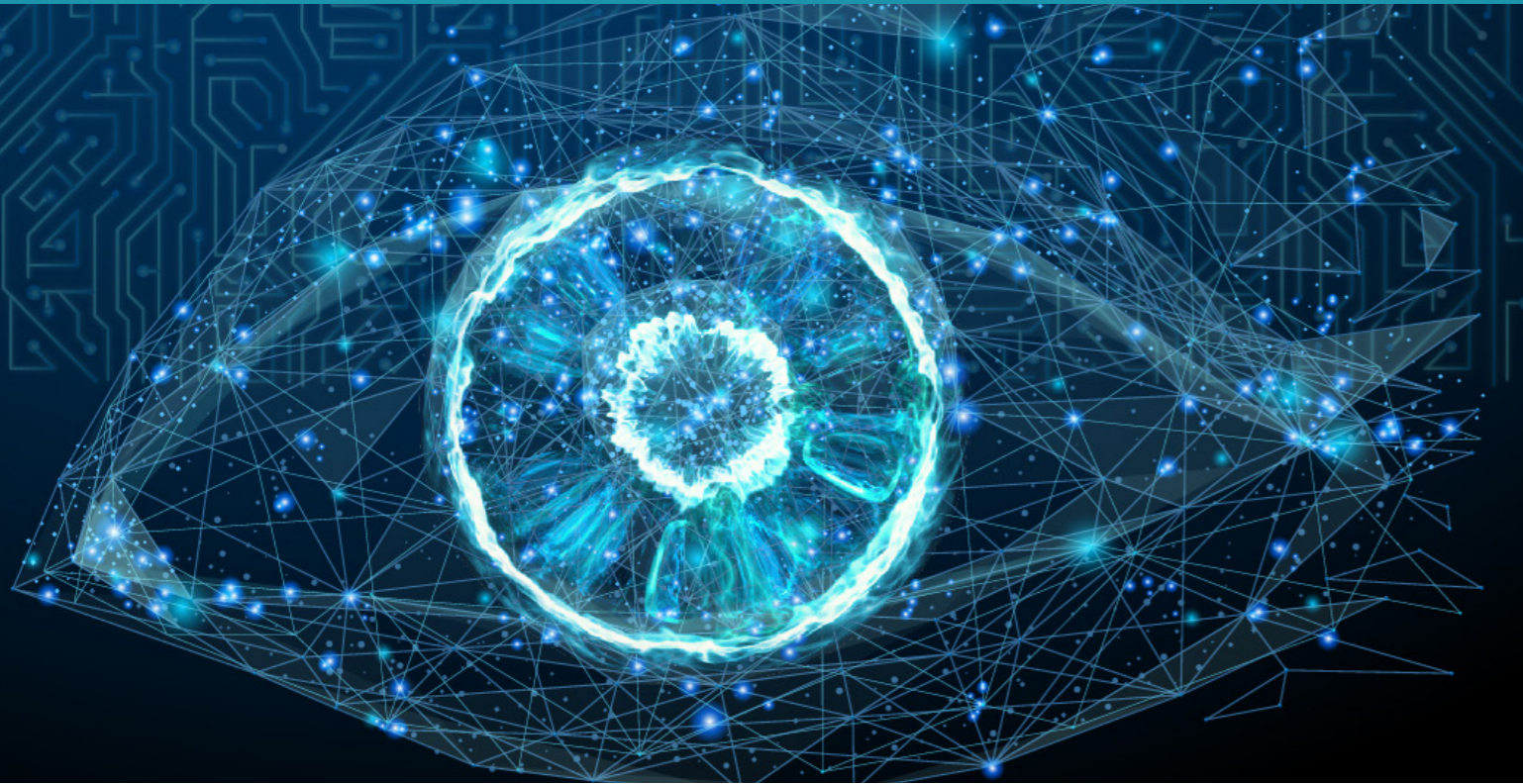

Seeing, Hearing, Touching, Moving

Sensing the Real World.

Today's robots are becoming more human-like, not only in terms of movement but also in how they sense the real world. The rapid evolution of sensor technologies for robotic applications is supporting this trend, and the ability of robots to make decisions based on sensory feedback will have massive industrial and societal impact.

A wide variety of sensors are needed to give a robot a complete picture of the environment in which it operates. So, what are the key technologies that help robots see, hear, touch and move, and how are they developing?

EVOLUTION OF SENSING TECHNOLOGIES

The first mobile robot capable of any level of reasoning about its surroundings was built in 1970 by the Stanford Research Institute (now SRI International) in California. The robot, named 'Shakey', combined multiple sensor inputs, including TV cameras, laser range-finders and 'bump' sensors to navigate.

In 1972, Waseda University in Japan created WABOT-1, the world's first full-scale humanoid robot, which could grip and transport objects with its hands using tactile sensors. A vision system was deployed to measure distances, while directions to objects were gauged using external receptors – artificial eyes and ears.

Just two years later, David Silver designed the Silver Arm, which was capable of fine movements that replicated human hands with feedback provided by touch and pressure sensors.

There have been many more notable advances since these early robot sensing efforts. Arguably the most famous was ASIMO, which was created out of Honda's humanoid project in 2000. ASIMO could communicate with humans, and recognise faces, environments, voices and postures.

Ongoing research into sensor capabilities has resulted in greater adoption in the industrial robot sector. And, as with all technologies that make the leap from research lab to commercial production, cost is falling in line with uptake. Thanks to the proliferation of industrial robots volumes will rise and costs will fall further, making the latest sensor technology available to all, not just multinational robot OEMs.

SOUND AND VISION

Fundamental to primary robot intelligence, vision sensing can be based on technologies ranging from the traditional camera, sonar and laser, through to the latest RFID technology.

Light detection and ranging (LIDAR) systems are also a popular choice for robot vision. This technology bounces light off nearby surfaces to create a 3D map of the world around it. LIDAR is like radar in its basic mechanics, but because it uses light, not radio waves, it offers greater resolution.

There are many key advances in vision-related hardware, not least the development of high-speed, low-noise CMOS image sensors, and new 2D and 3D vision systems.

2D vision is essentially a video camera that can perform tasks ranging from the detection of motion to locating parts on a conveyor, thereby helping the robot coordinate its position. 3D vision systems normally rely on either two cameras set at different angles, or laser scanners. With this technology, a robot can detect parts in a tote bin, for example, recreate a part in 3D, analyse it and pick the best handling method.

Complementing vision sensors, audio sensors based on multiple microphones can be deployed to determine the direction and intensity of a person's voice, or listen to sound-based commands. Sensitivity can be adjusted using a potentiometer. Microphone technology has been around for a long time, but in the future, sound/audio sensors may be able to determine the emotional status of a human voice. However, this will demand analogue-to-digital conversion (ADC) and digital-signal processing (DSP) electronics in tandem with a powerful microprocessor and advanced software.



TOUCH

A sensing device that specifies contact between an object and sensor is a tactile sensor. These are found in everyday objects such as lamps that brighten or dim by touching the base, for example. The stimulus-to-response pathways witnessed in electronic touch-sensor operations replicate human processes that involve the skin, signal transmission via the nervous system, and brain.

Touch-sensor options include wire resistive – which measure the resistance between electrically resistive layers at the point of contact to determine the touch position, surface capacitive, projected capacitive, surface acoustic wave and infrared. Among recent advances in this area are adaptive filters. Applied to robot logic, such filters enable the robot to predict the resulting sensor signals of its internal motions, screening out any false signals. As a result, contact detection is improved and false interpretation reduced.

FORCE/TORQUE

As vision gives eyes to a robot, force-torque (FT) sensors give ‘feel’, enabling users to know the force a robot applies with its end effector. This can aid assembly operations – if a component does not fit well, for example, feedback from the sensor allows the robot to adjust its movement and re-orientate the part in the correct position.

An FT sensor detects different forces and torque levels in up to three geometric (XYZ) axes. Typically, the sensors are fitted at the robot flange or wrist so that effort can be measured effectively. Selection criteria for FT sensors include the number of measured axes, physical dimensions, force range and communication rate.

FT sensors are important in collaborative and safety-based functions, as force-limiting capability is essential to robotic systems that can work safely alongside humans.

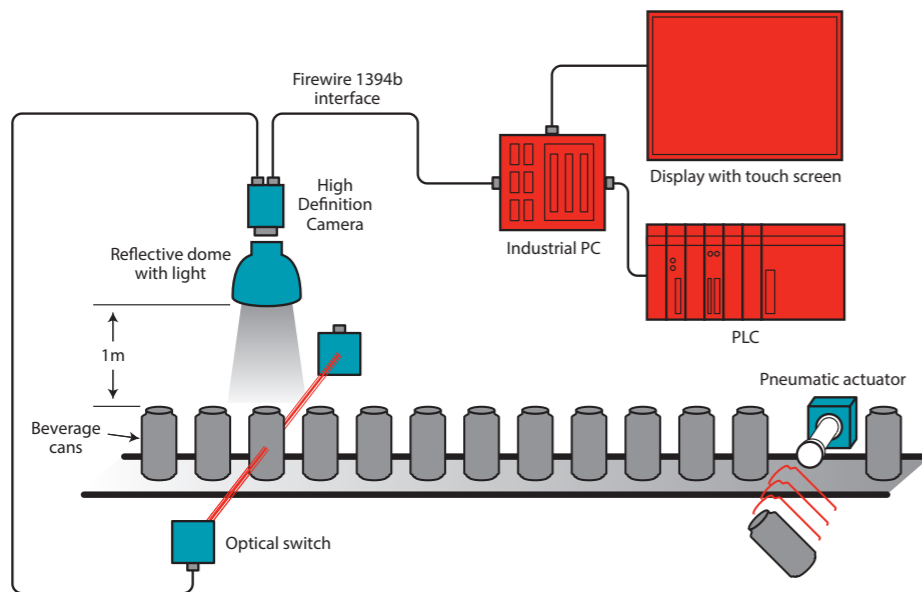

Cameras can be used to recognize the location and orientation of objects on a conveyor belt

PROXIMITY/COLLISION DETECTION

Proximity sensors that detect the presence of nearby objects (or targets) without any physical contact are placed on moving robot parts such as end effectors, with the sensor emerging from sleep mode at a pre-specified distance. Working on the principle that ‘no contact is better than some contact’, one of the growth applications for proximity sensors is in collaborative robots, where they help to ensure a safe environment for human workers.

Different targets demand different sensors – a capacitive or photo-electric sensor, for example, may be appropriate for a plastic target, while inductive proximity sensors always require a metal target.

Sometimes user-adjustable, the maximum distance that a proximity sensor can detect targets is defined as its nominal range.

Proximity sensors typically offer high reliability and long functional life thanks to the absence of moving parts and the lack of physical contact between sensor and target. The wide variety of types includes those based on capacitive, eddy-current, inductive, magnetic, optical, photo-resistive, radar, sonar, ultrasonic and fibre-optic technologies.

Infrared sensors, for instance, transmit a beam of light that is reflected off a target and captured by a receiver, while ultrasonic sensors generate high-frequency sound waves whereby the presence of an echo suggests interruption by an object.

Using ultrasound rather than infrared solves the challenge of the short range, as well as the need for calibration. Ultrasound is reliable in any lighting conditions, and is fast enough to take care of collision avoidance for a robot. It can also handle being shaken, as long as the motion is not exceptionally fast.

POSITION

Used for sensing and controlling arm position, the three most common types of position sensors are encoders, potentiometers and resolvers.

Popular types of encoders – which are used for converting angular or linear displacement into digital signals – include linear, rotary, incremental and absolute.

Incremental encoders have a glass disc with discontinuous stripes. A phototransmitter is present on one surface of the disk and a photoreceiver on the other. When the disk commences rotation, the light beams are finished alternately and interrupted, delivering output as a pulse train whose frequency is proportional to the disk rpm. Used mostly to determine the absolute position of a part, absolute encoders are similar to incremental encoders, with the stripes set to give a binary number that is relative to the shaft angle.

Potentiometers, which can also be used to determine position, are essentially ‘voltage divider’ systems that produce an output voltage proportional to the position of a rotating wiper in contact with a resistive element. The wiper separates the voltage of the resistive element into two parts and, by measuring voltage, its position can be pinpointed.

Like a potentiometer, resolvers are analogue devices. In this case, rotary electrical transformers are used for calculating degrees of rotation. An AC signal is needed and the output signal of a resolver is proportional to the angle of rotating element with respect to the fixed element.

FURTHER ADVANCES

Robot sensing technology is advancing rapidly, offering up a myriad of advanced and sometimes radical industry solutions for safety, and supporting more effective forms of collaboration between people and machines.

Existing sensors, including cameras and depth sensors, are often affected by lighting and offer only a rough idea of a person's position in 3D space. Emerging safety systems allow people to work in closer proximity to powerful robots, which will shut down completely if a person moves too close. By tracking a person's motions more precisely (for instance using enhanced radar techniques), next-generation systems will make it possible for powerful robots to work in concert with a human co-worker. Such technology might also improve efficiency, because workers could grasp something that a robot has finished working on, without fear of being injured.

Another recent breakthrough is a flexible sensor 'skin' that can be stretched over any part of a robot's body to accurately convey the information about shear forces and vibration that is critical to grasping and manipulating objects. The skin mimics the way a human finger experiences tension and compression as it slides along a surface or distinguishes between textures. This tactile information is measured with similar precision and sensitivity as human skin, and could vastly improve robots' ability to perform all tasks, from industrial to medical procedures.

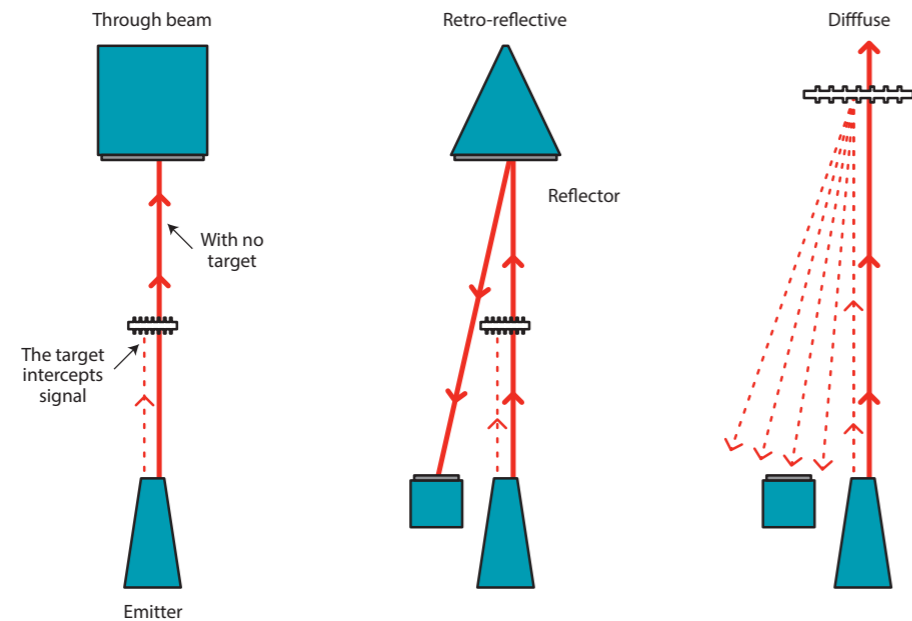

Sensors can receive signals directly or by reflection until broken by an object; diffused signals are reflected back by the object

ROBOTICS SENSOR MARKET

The increased use of robots in industries such as automotive, food and beverage, renewable energies, logistics, medical care, and telecommunications is a major factor that is expected to augment growth in the industrial robot sensors market over the coming years.

Research from analysts such as Technavio suggests that the global industrial robot sensors market will grow at a CAGR of around 8% by 2021. One of the primary drivers for this is the miniaturisation of sensors, which has helped to reduce costs. As the price of sensors declines, there will be a proportional rise in industrial robots that can work in collaboration with humans.

According to another market research expert, IDTechEx, vision systems alone will command a worldwide market worth \$5.7 billion by 2027, while force sensing technologies will reach over \$6.9 billion.

In Technavio's study, analysts have estimated that the materials-handling segment will dominate the industrial robot sensors market during the forecast period, particularly in sectors such as automotive, food and beverage, packaging, and pharmaceutical. Furthermore, increasing momentum behind Industry 4.0 will also prove a significant factor, driving market growth in the coming years.

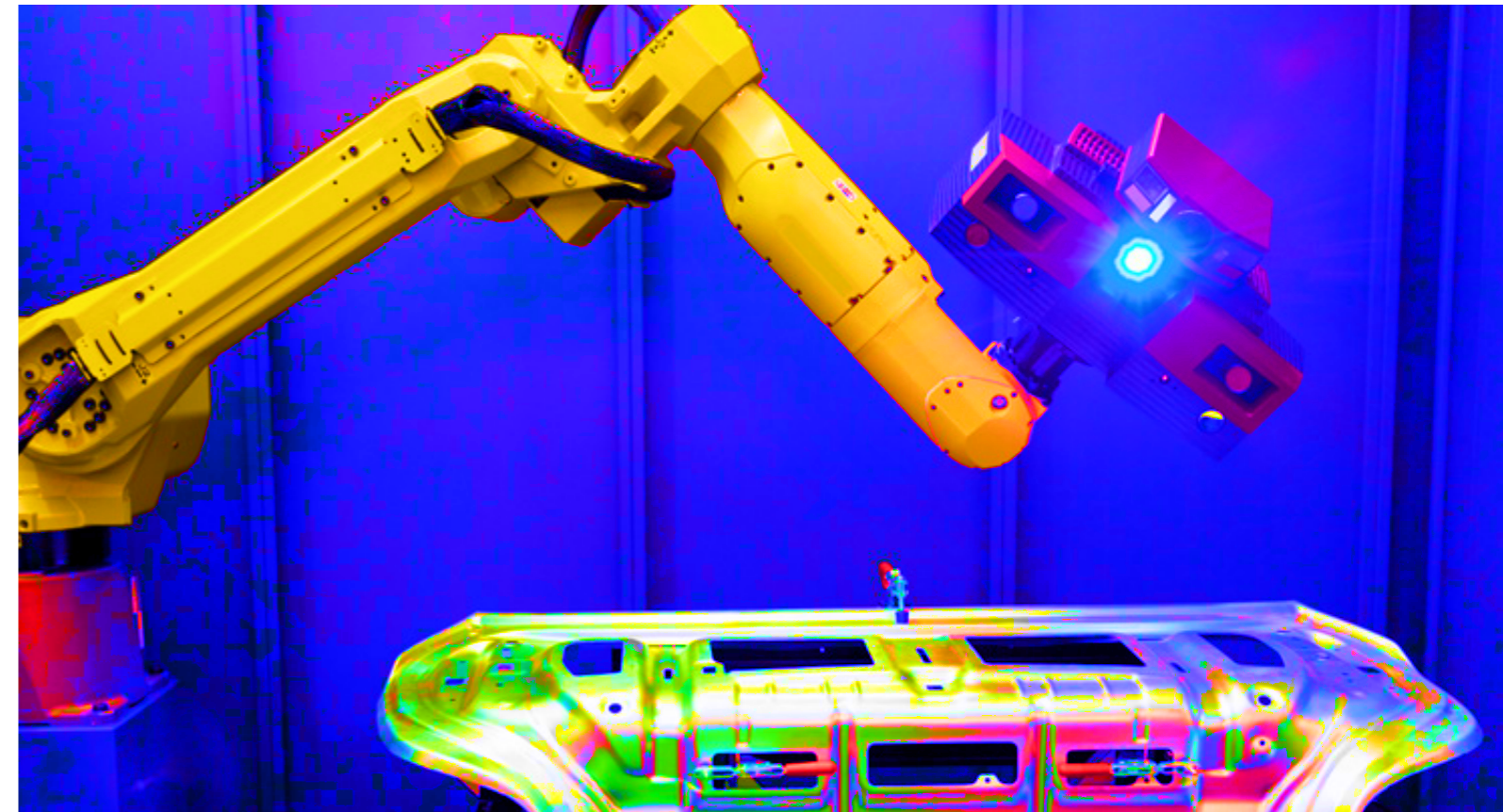



KEY FACTORS TO CONSIDER



01

Match sensors to capability. If desired, all human senses can be replicated using the latest sensor technology, though not all will be necessary in the majority of industrial applications.



02

For vision, will camera technology be sufficient for the application? If so, will 2D or 3D vision be needed? Or should further options including LIDAR, sonar, radar and RFID be investigated?



03

How many audio sensors, if any, are likely to be required, and where will be the best positions?



04

The uptake of touch/tactile sensor technology has grown enormously in the past decade, and growing numbers of industrial robots are taking advantage. Choose between touch sensor types such as wire resistive, surface capacitive, projected capacitive, surface acoustic wave and infrared.



05

When choosing force-torque sensors to detect the different forces and torque levels applied on the robot wrist or tool, consider the number of measured axes needed, force range, communication rate and physical dimensions.



06

Proximity sensors also have many uses in robotics, particularly with the rapid emergence of collaborative models. When it comes to selection, identifying target material, nominal range and lighting conditions may all be important.



07

Options for position sensors are typically limited to encoders, potentiometers and resolvers, and understanding of whether relative or absolute position is needed will be key.



Robot Power and Movement

Energy, Control and Actuation for Modern Robotics.

Providing the power, control and actuation that underpins the ability to move is fundamental to modern robotics, which is why identifying the optimum power source, actuators, motors and drives needs to happen as early as possible in the robot design process.

A fundamental factor guiding selection is the type of robot and its intended use. Within industry, robots take many forms, including cartesian, SCARA, cylindrical, delta, polar, gantry and articulated arm. Target applications include assembly,

welding, machine tending, packaging, painting, pick and place, inspection and testing, to list but a few.

The type of power source is a primary consideration, particularly with regard to reliability, size, weight and lifecycle. To achieve optimised motion, robot OEMs also need to think about the most appropriate motor and actuators, and how these are best controlled.

BATTERIES

Batteries are the most commonly selected source of electrical power and the question of which battery type is most suitable hinges on criteria such as safety, life cycle, weight and cost.

Both primary (non-rechargeable) and secondary (rechargeable) batteries are found in industrial robot applications. Although primary batteries present the obvious disadvantage of requiring replacement, they typically provide greater power for their size, making them suitable for certain light-drain applications. More often than not, however, rechargeable batteries are preferable.

Historically, the common types of rechargeable batteries for robot applications are nickel-cadmium (NiCd) and lead-acid. In addition, gelled lead-acid batteries, which are capable of providing power of up to 40 Wh/kg, have sometimes been deployed. Further secondary battery technologies include nickel-metal hydride (NiMH), silver-zinc and lithium-ion.

Now, however, lithium technologies have become the popular choice for today's robot designers. Indeed, the performance, shelf-life and scalability of lithium-ion batteries – lithium battery banks can be scaled to meet most automation applications – have ensured wide appeal for the industrial robot arena. Among the many advantages of lithium-ion technologies is their light weight. Moreover,

the lithium element itself is particularly reactive, which means it has the ability to store a lot of energy; typically around 150 Wh of electricity can be stored in 1 kg of battery. This compares favourably to a NiMH battery pack, which can store 60 to 100 Wh.

It is worth mentioning welding robots, commonly found in sectors such as automotive. Here, the same power source that feeds the welder can be used to power the robot's electronic drives and motion-control components, and for these applications inverter power sources prove popular. Some of the latest inverter technologies automatically adjust input power while maintaining a constant output, and provide power surge blockers to ensure performance is unaffected by the simultaneous use of other devices requiring high current.

Clearly, battery geometry is highly influential when it comes to selection and robot type, and form will dictate which battery types should be included in the decision-making process. Similarly, weight is a significant factor and may depend on whether the robot is intended to be portable or fixed.

Also, as competitive advantage can be built on the time that a robot is able to run before additional charge is required, durability and capacity will be key aspects of the life cycle element of the battery selection equation.



PHOTOVOLTAIC (PV) CELLS

Although the use of solar power has brought benefits to many areas of the engineering world, it has yet to find its place in industrial robotics. Some biology, electronic, aesthetics and mechanics (BEAM) robots, such as automated lawn mowers and vacuum cleaners, do currently use PV technology. The common configuration sees a solar cell, via appropriate circuitry, charge a capacitor to a set voltage level and then discharge it through the motor(s).

Upscaling this technology to industrial robots has yet to occur on a commercial level. There are a number of reasons behind the lack of progress, but mainly it's due to the rather low power density of solar cells (Wp/m²), which is insufficient for most modern industrial robots.

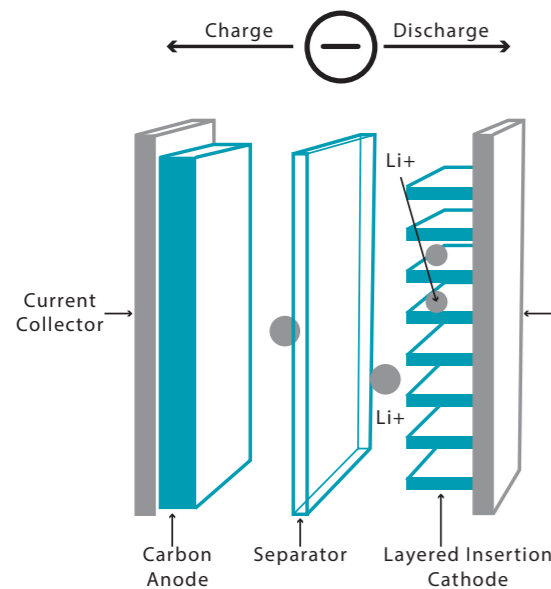

Lithium-ion batteries are the cell of choice today, although advances in fuel cell technology could see this change in the future

FUEL CELLS

A far more likely future replacement for conventional batteries in industrial robots is fuel-cell technology, which is able to generate electricity by combining hydrogen, methanol or simple alcohol with oxygen. At present, cost is the restrictive barrier, but this could change as fuel cells are adopted in wider consumer markets.

Fuel cells supply energy by deriving power from a hydrocarbon source at high efficiencies of up to 75%. A typical configuration includes two electrodes located either side of a conductive electrolyte. Current is generated using a concept similar to that of fuel combustion, whereby protons are allowed to pass through the membranes and electrons are forced to bypass from anode to cathode via the electric circuit. Fuel-cell efficiency can be increased even further by making use of waste heat.

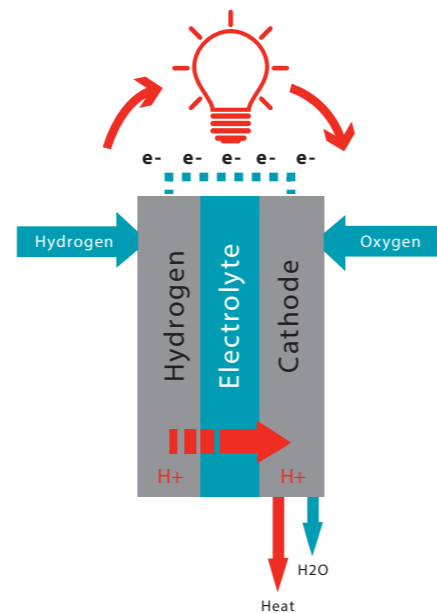

ACTUATORS

With the decision about the power source complete, attention turns to the actuator technologies and motors needed for linear and rotational motion.

STEPPER MOTORS

Stepper motors are typically found in applications where cost is the primary factor, such as in common pick-and-place robotic devices. Among the principal benefits are high-accuracy positional control – which is why they are often used for systems such as 3D printers and CNC milling machines. This is because stepper motors are specifically designed to offer high holding torque, which in turn provides the ability to step incrementally to the next position. They can be used to advantage in applications where there is a defined need to control rotational angle, speed, position and synchronism. Furthermore, because stepper motors deliver maximum torque at low speeds they are a good choice for applications requiring low speed and high precision.

While stepper motors proved popular in early robot applications, their use has reduced in recent years. Among the reasons for this are factors such as efficiency, the need for encoders or limit switches to establish reference positions, and the potential for missed steps if overloaded. However, just as likely is the advent of more advanced brushless AC servomotor technology.

SERVOMOTORS

While many early electric robots used DC servomotors (as they give reasonable power output with a good degree of speed and positional control), most new industrial robots use brushless AC servomotors. Such motors offer the benefits of higher power output and virtually silent operation, while the absence of a brush means these high-torque devices are highly reliable and require virtually no maintenance.

Servos also have an inherent benefit in that they provide a high degree of angular precision, rotating only as much as requested before waiting for the next signal.

The principal difference between digital and analogue servos is the signal and how it is processed from the receiver to the servo, and how the servo uses this information to send power to the motor. Analogue servos control motor speed by giving on/off voltage signals to the motor, whereas digital servos feature a small microprocessor that analyses the receiver signals and processes them into very high-frequency voltage pulses to the motor.

Unlike analogue servos, which send out 50 pulses per second, an advantage of digital servos is their ability to send pulses upwards of 300 pulses per second. The pulses are shorter in length, but with so many voltage pulses, the motor accelerates faster and provides constant torque. With digital servos, the amount of power sent to the motor can also be adjusted to optimise performance and precision.



EFFICIENCY, SIZE, ACCURACY, RELIABILITY, SPEED AND TORQUE

Selecting the optimum motor is one of the most important parts of a robotics project and is based on considerations that include torque, speed, precision, voltage, cost and form factor.

In a robot, motor torque is typically conveyed to a wheel or actuator that subsequently prompts rotational or linear robotic motion. To estimate the required torque, engineers need to determine the mass of intended maximum payload, as well as the system's static, dynamic and rolling friction.

For wheeled robots, it is important to specify the speed that the wheels need to turn. With faster speeds, there is usually a trade-off with precision. Ultimately, to achieve the accuracy required of robotic arms, servomotors are the popular pick chiefly because they have internal position regulation and are geared down to lower speeds, resulting in very precise position control.

Another important consideration is operating voltage. Before planning what battery packs will be used in the project, it is best to determine the nominal voltage when the motor runs. Usually, the higher the voltage, the higher the motor speed. The 'voltage constant' on the motor datasheet can be used to determine the speed-per-volt.

HYDRAULIC AND PNEUMATIC ALTERNATIVES

Hydraulics were a fairly common sight on early robots as this technology is more rigid and controllable than pneumatics, and could provide greater power than the electric drives available at the time. Hydraulics also offer the potential to create a large reduction ratio.

The principal disadvantage of hydraulics is the comparatively slow pace of operation, while the high pressures involved mean that leaks can be problematic.

In terms of pneumatics, many simple pick-and-place systems are driven using compressed air, which introduces a level of affordability but has the disadvantage of being difficult to control. Essentially, the compressibility of air introduces an additional 'dead-time dynamic' to the system that makes control more challenging.

Pneumatics are also used with a number of industrial robots to drive end effectors; pneumatic cylinders can deliver large forces and are a good choice for larger grippers. It is also possible, although fairly uncommon, for some robots to use pneumatic cylinders to move their body using an onboard

bottle of pressurised air as the power source. The factor limiting wider adoption tends to be that pneumatics can only produce relatively small and simple back-and-forth motions.

CHOOSING THE RIGHT MOTOR-CONTROL TECHNOLOGIES

Choosing between a servomotor and a stepper motor comes down to a trade-off between complexity and control certainty. A stepper motor is simpler in configuration because, unlike a servomotor, it does not require an encoder.

This design concept makes stepper motors simpler to control, but only if the robot has low performance requirements. Any robotics engineer wanting to push stepper motors close to their limit will find they become far more difficult to predictably control.

One of the benefits associated with stepper motors is their ability to be controlled in an open-loop system. Open-loop control means there is no requirement for feedback information concerning position, thus eliminating any need for encoders or resolvers, and the costs these incur. Position is known simply by keeping track of the input step pulses.

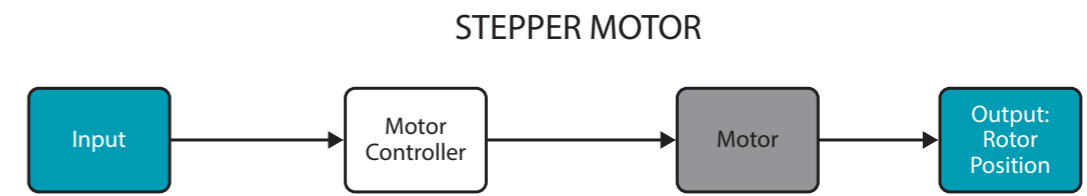
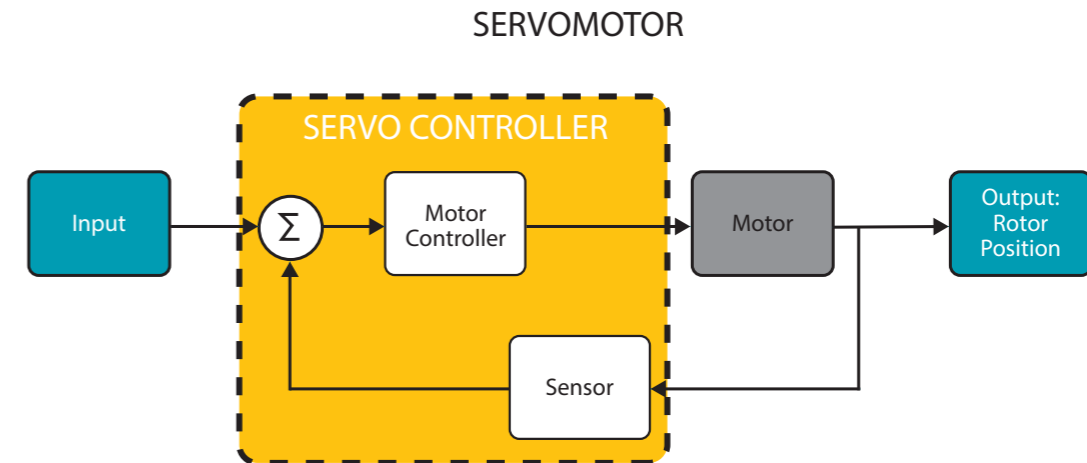

Servomotors use a closed-loop control system for positioning, while stepper motors can be positioned to a specific angle of rotation

Servomotors are used in closed-loop systems with a digital controller that sends velocity commands to a driver amplifier, which in turn feeds the servomotor. A feedback device (encoder or resolver) provides information on the servomotor's position and speed. To break it down further, the device is controlled by a feedback signal generated by comparing output signal and reference input signal.

As a result of the closed-loop system, a servomotor can operate with a specific motion profile programmed into the controller. Servomotors are controlled using a principle called pulse width modulation (PWM), with the angle of rotation determined by the duration of the applied pulse.

MOTOR/ACTUATOR MARKET

The global market sales figures for industrial robots in 2017 are estimated to be around \$14 billion, which would be up 13% on 2016. By 2025, this figure is expected to reach almost \$34 billion. So, nearly threefold in less than 10 years. All of these robots will need motors, actuators and batteries.

As a result, according to industry analysts Technavio, the global motors and actuators market for industrial robot applications is forecast to grow at a CAGR of 6.46% during the period 2017 to 2021.

Global shipments of industrial robots could triple by 2025

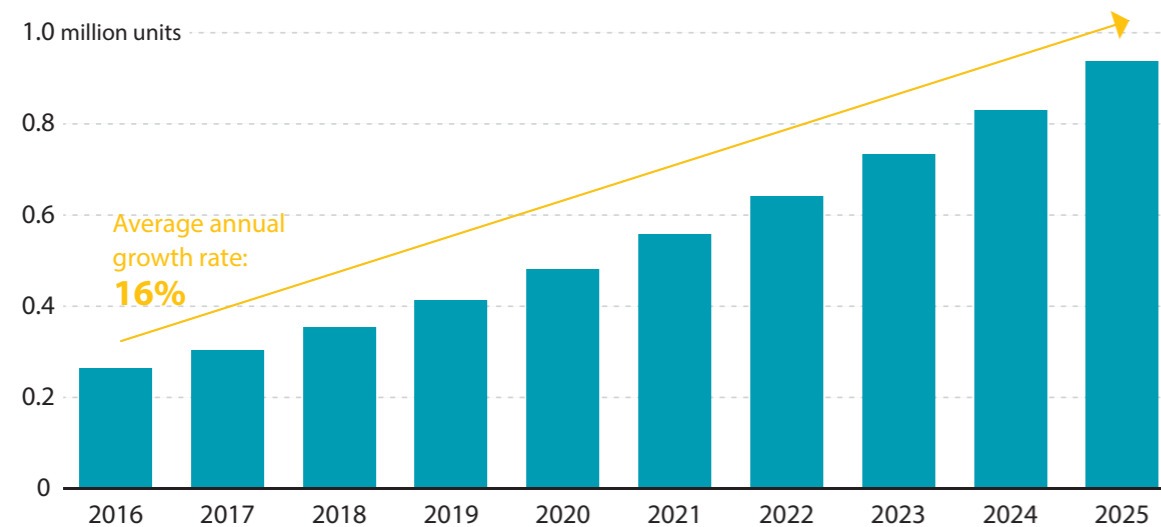

With a growth rate of 16% per year, shipments of industrial robots could triple by 2025 (Source: ABI Research)

KEY FACTORS TO CONSIDER



Power sources

- When it comes to power sources, batteries are the current technology of choice. Both primary (non-rechargeable) and secondary (rechargeable) types can be deployed, although the latter are generally considered the popular pick.
- Types of secondary battery include NiCd, NiMH and lithium-ion. Power density is highest with lithium batteries.
- Important factors in the purchase decision are safety, life cycle, size, weight and cost.
- Alternative power sources include PV, fuel cells, thermoelectric generators, super-capacitors and flywheel energy storage. Extra-large robots weighing several tonnes will require a diesel generator or three-phase mains supply.



Actuators

- Although brushless AC servomotors are generally the first choice for new-build industrial robots as a result of their angular precision, high power output, reliability and low noise, stepper motors can also be used.
- Stepper motors offer good positional control and high holding torque.



Control

- As a stepper motor does not require an encoder, it is simpler to control, although there are limitations in terms of performance.
- Pushing a stepper motor to its limits brings a level of unpredictability to the control equation.
- Servomotors are favoured for industrial robots thanks to their integral position feedback capabilities. If the target position or speed is not reached, this is relayed to the servo loop for correction.

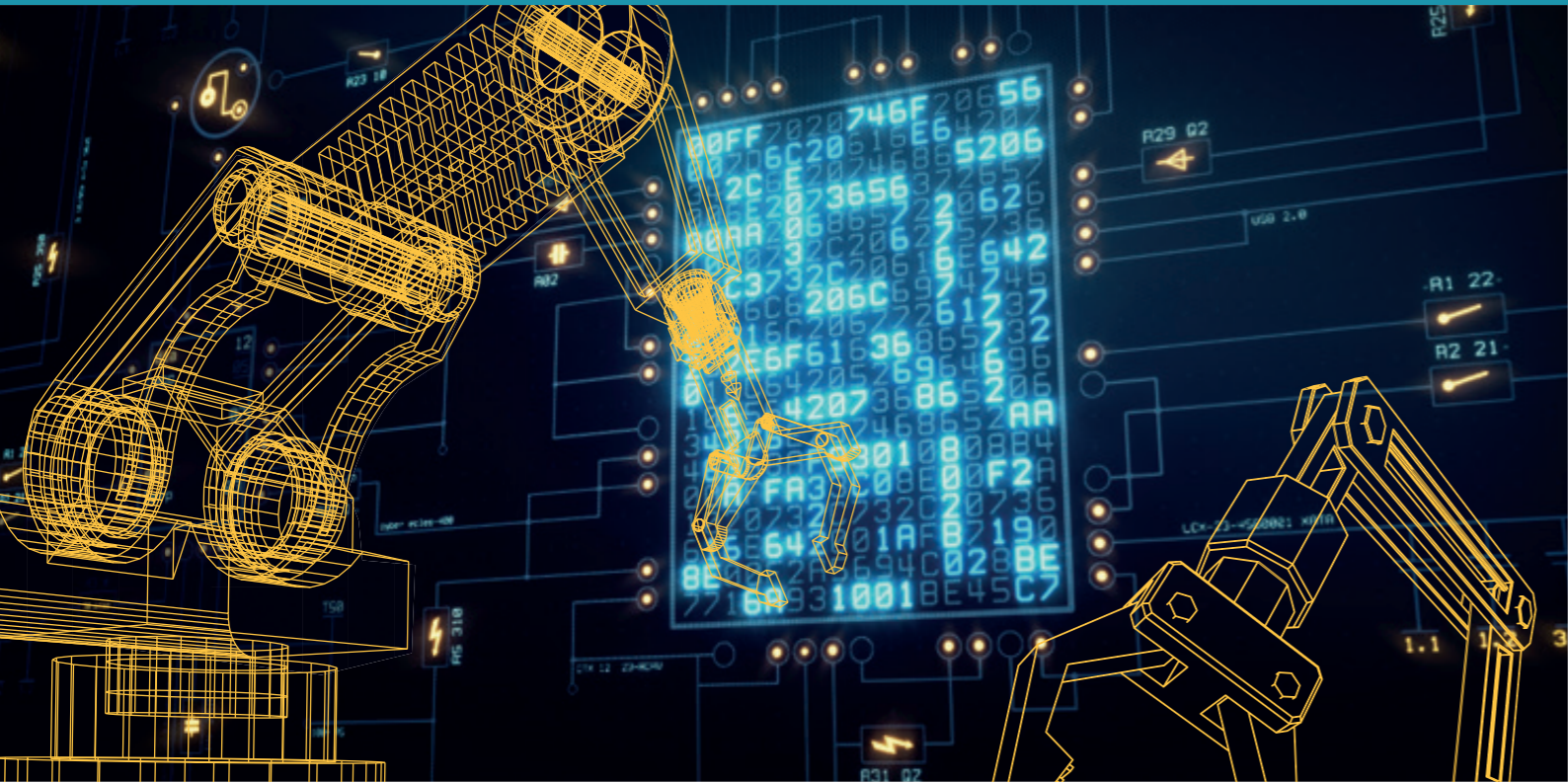

Computational Options for Robotics

Robot architecture and design now spans a wide range of functions and abilities. This strongly affects the processing power and what is used to deliver it. Within the controlled environment of a safety cage, a production robot needs relatively few safeguards and can make use of simple procedural control strategies.

Designers need to ensure that the robot will stop if the cage is opened, or if parts are not aligned as expected. Even so, many of the safety challenges can be met using simple hardware interlocks rather than complex combinations of image sensors and software. The key processing requirements are to ensure efficient and precise control of motion.

This primarily demands the use of microcontrollers or digital signal processors to manage the flow of power to motors and other actuators.

Conventional production robot designs tend to be inflexible. Each of their programs needs to be programmed, simulated

and tested extensively before the robot is allowed to proceed. In manufacturing, users want robots to be more flexible so that they can be quickly assigned to different tasks. They also need to be able to move around the production floor, which entails operation outside the safety cage. These requirements call for greater processing power to provide the robot with the ability to navigate without accidentally colliding with objects or harming bystanders.

As a result, robots need to be able to process sensor input in real time and make intelligent decisions on the fly as circumstances change. The further robots move away from the safety cage and the more they interact with humans, the more processing power they will need as they move beyond the relatively controlled environment of the shop-floor. Service robots and delivery drones need to be able to react intelligently to complex situations.

In these more advanced scenarios there is a clear need for greater software sophistication, which goes hand in hand with computational throughput. The designer has a high degree of choice as to how to supply the required processing power, not just in terms of suppliers but overall architecture.

The microcontroller unit (MCU) has for many years been the computational element of choice for basic robots. The core of the MCU is the microprocessor. Initially, the microprocessor cores in MCUs were optimised for simple arithmetic and logic-level control, but since their introduction almost 50 years ago, the performance and data-handling capabilities have expanded dramatically. Today, microprocessor cores

that natively operate on 32-bit data words and which offer performance features such as pipelining and Harvard architecture are now offered at a cost level that allows even simple systems to make use of them.

In a typical 32-bit microprocessor core, such as the ARM Cortex-M3, there is an instruction pipeline that separates execution of commands into a number of phases. In the M3 pipeline, first the instruction is fetched from a local cache. If the instruction is not in the cache, it first must be loaded from the main memory. Once in the pipeline, the instruction bytes are decoded to evaluate which functional units need to be activated to execute the instruction. Finally, execution takes place.

Pipelining is used to hide effects such as the latency of memory. It allows execution of multiple instructions to be overlapped and helps boost clock speed, as fewer logic steps are needed per cycle. Faster processor cores use more extensive pipelines that can be ten stages long or more. The drawback of long pipelines is high branch latency. If a branch is taken, it takes time to refill the pipeline with the instructions needed for the new branch.

Support for interrupts allows the processor core to suspend execution of the main program temporarily and handle other tasks. Interrupt handling is a key component for applications that need real-time response to events. Without it, the program code would have to contain loops that continually poll for information on external events, which would be far more wasteful of computational capacity.

A priority scheme employed by most processor cores allows interrupts from relatively unimportant peripherals to be ignored while the processor takes care of critical routines, such as transferring control from one task to another or the input from a critical interrupt. The result is a highly flexible architecture that can handle many different types of real-time application.

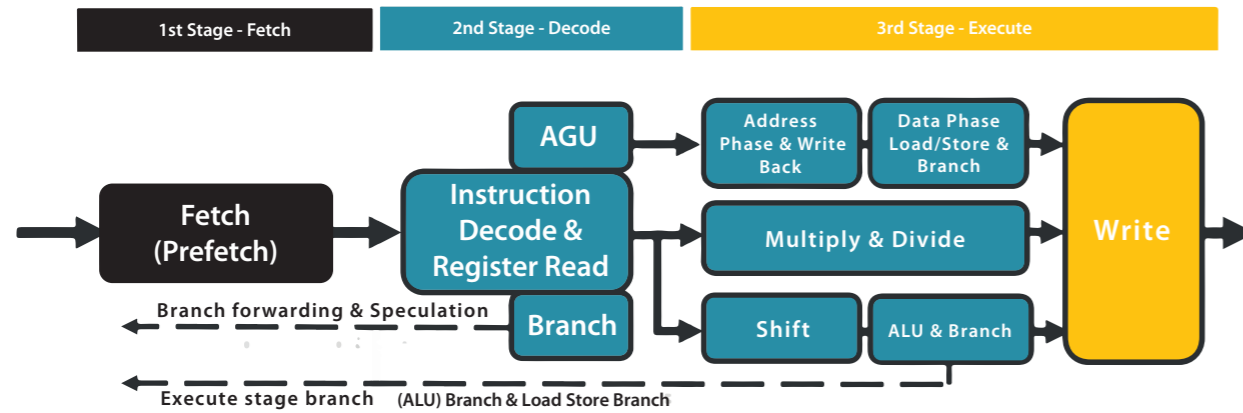

The ARM Cortex-M family of processors are the backbone of many microcontroller products

An important and specialised variant of the microprocessor for robot designers is the digital signal processor (DSP).

This is a processor core that adds instructions and execution hardware optimised for signal-processing algorithms such as filters and fast Fourier transforms. Such instructions include fast fused multiply-add operations that are found in practically all DSP algorithms. Because DSP code operates on data structures such as matrices and vectors, it is relatively easy to parallelise the work. This has led to the implementation of single-instruction, multiple-data (SIMD) execution units that perform the same operations – such as multiply-adds – on multiple elements of an array at once. The result is much higher speed for comparatively little additional complexity or cost.

An MCU includes a number of integrated peripherals that are arranged around the processor core. Typically, in an industrial or robotics-oriented MCU, the peripherals range from memory arrays to advanced timer-trigger units, which are used to offload the burden of pulse width modulation (PWM) from

the microprocessor. PWM is a core component of almost all motor-control strategies and so features prominently in robotic design. Other system-on-chip (SoC) devices add more features around an MCU such as wireless transceivers, dedicated encryption and authentication logic and graphics accelerators.

The use of intelligent peripherals also illustrates an increasingly important design principle for robots: the exploitation of distributed control and hardware acceleration. A microprocessor can be used to implement PWM control, but it is often a poor allocation of resources. The core of the problem is that the software repeatedly has to switch power between transistors in the half-bridge that controls current flow to a motor after pre-programmed intervals. Interrupts from a real-time clock or counter can readily trigger handlers to switch power state and then configure the timer for the next cycle. But this results in a high interrupt frequency for what is an extremely simple sequence of operations.

A PWM controller combines timer and switching logic, which removes the requirement to have the microprocessor core interrupted for each switching operation. Software only needs to update the timers periodically to set the required

PWM duty cycle. Thanks to a comparatively small amount of additional logic that can operate independently of the processor for substantial periods of time, software efficiency is greatly enhanced. The architecture has a common theme, with other hardware-offload mechanisms that will become increasingly important in robotic design. Hardware peripherals take care of frequent events in real time; software sets policy for those peripherals.

With hardware peripherals, designers are limited to the functions offered by IC suppliers, although the inclusion of sequencers based on hardware state machines increases their flexibility. For example such sequencers can read values from an A/D converter, transfer data values to main memory using direct memory access (DMA), and set and reload timers, all without involving the CPU core. However, the options remain limited.

The field-programmable gate array (FPGA) provides a way to create custom hardware peripherals that can be optimised to specific robotic-control and machine-learning functions.

The core of most FPGA architectures is a programmable look-up table that can be configured to implement any logic function that can be expressed as a truth table. Using programmable switches in the interconnect fabric, the look-up tables are wired together into complex combinational logic circuits. Typically, each look-up table is accompanied by one or more registers and additional support logic, such as carry-chain inputs and outputs, to make it possible to implement arithmetic adders efficiently. Together, these functions make up a logic block that is replicated many times across the FPGA.

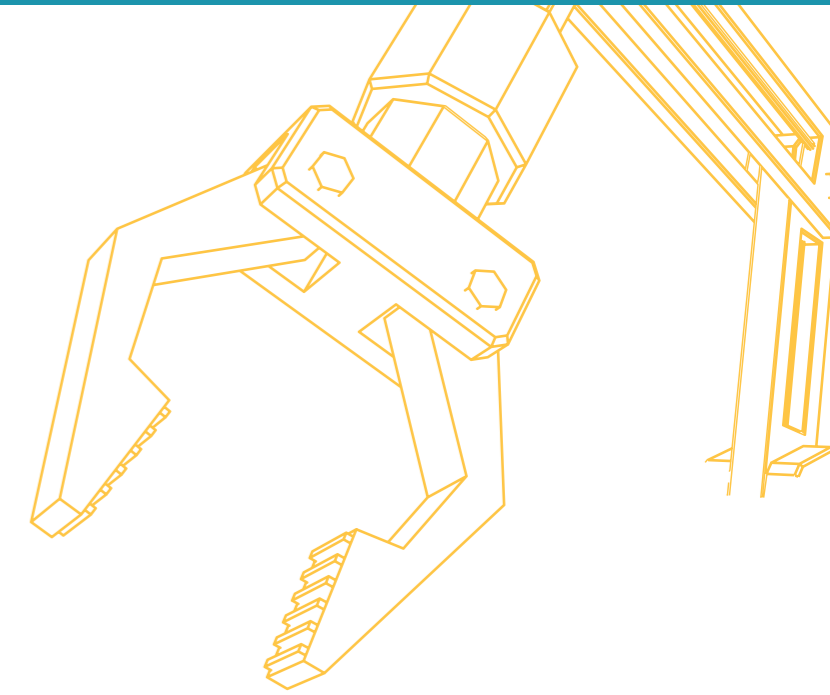

A drawback compared to fully customised logic is that their silicon efficiency is much lower. It takes 10 to 20 times as much silicon area to accommodate a logic circuit on an FPGA fabric compared to a custom, standard-cell implementation.

However, most FPGAs support reprogramming of the logic array even in a running system. This makes it possible to share resources by having accelerators dynamically loaded into the fabric only when they are needed. This approach also allows greater flexibility in the end design, enabling it to support new hardware and additional features.

Since their introduction in the 1980s, FPGAs have acquired other features that improve overall density. Memory blocks allow the creation of buffers and caches close to the programmable logic. These have been joined more

recently by DSP engines. In many cases, the DSP engines are implemented using a building-block approach, composed of 8-bit or 16-bit units, that allows them to be combined to support higher-precision datatypes.

DSP units make FPGAs highly suitable for processing the inputs from sensors that produce large amounts of data, such as cameras, radar and other types of image sensors. A typical application is to use a combination of DSP units and logic accelerators to handle algorithms such as image warping

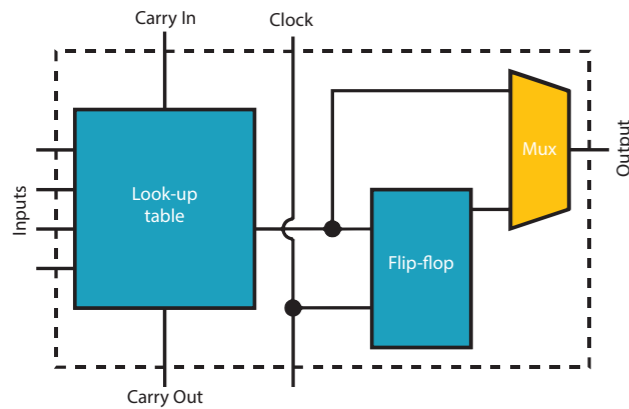

The FPGA Look Up Table (LUT) is what gives an FPGA its flexibility

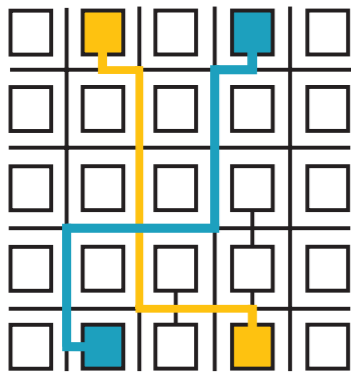

FPGA LUTs are then linked together through a routing matrix to achieve the desired functionality

and lighting compensation that provide more consistent inputs to machine-learning and similar functions. These functions can be coordinated by custom microprocessor cores implemented in the programmable fabric, which act as microsequencers for the different processing primitives.

Another option, particularly for image-processing tasks, is to employ a graphics processing unit (GPU) or vision processing unit (VPU). These contain highly parallelised DSP engines optimised for image processing. For robots that need very high levels of environmental awareness, these dedicated units may be combined with multiple CPUs – sometimes on the same chip, as a heterogeneous multi-core SoC.

The use of multi-processing can also be harnessed to improve overall reliability and safety. A problem for any computer-based design is its reliance on memory technologies that are vulnerable to ionising radiation. When ionising radiation hits the silicon substrate of an IC, it triggers a cascade of free electrons that flip the logic state of a transistor. In combinational-circuit transistors, the effect is usually transitory and captured only rarely. However, memories and registers are more vulnerable to the change because of the way they recycle their contents to prevent stored data leaking away. Error checking and correction (ECC) codes help control the problem. The probability of a single-event upset increases with memory density, which makes it an increasing problem as these ICs continue to scale according to Moore's Law. Also ECC may not catch all of the errors, which can lead to a program acting on incorrect data and, ultimately, a failure in control. In a robot interacting with the public, this cannot be allowed to happen.

Techniques such as redundancy deal with the problem by having individual processors check each other's work. The processors may be of the same type and run the same code. Checking logic compares their outputs and uses voting to determine which operation to allow or demands that operations are re-run until the processors agree.

The use of three processors with majority voting is more expensive but less intrusive, as re-running operations can incur unwanted delays. Modular redundancy can also be implemented at the gate level.

The processors in a redundant arrangement need not be identical. Some architectures have a less performant processor act as the checking engine. Rather than running the same software, it simply performs consistency checks and forces re-execution if a check fails or, in more extreme cases, a full reset.

To minimise the chances of systematic design errors creeping into the equation, duplicated processors may be designed and implemented in different ways. This is a technique used on some multi-core SoCs developed for automotive safety systems.

The result is that robot designers can now choose from a wide range of architectural options that can take them from simple designs through to highly flexible machines that can react intelligently to problems and obstructions and keep running smoothly.

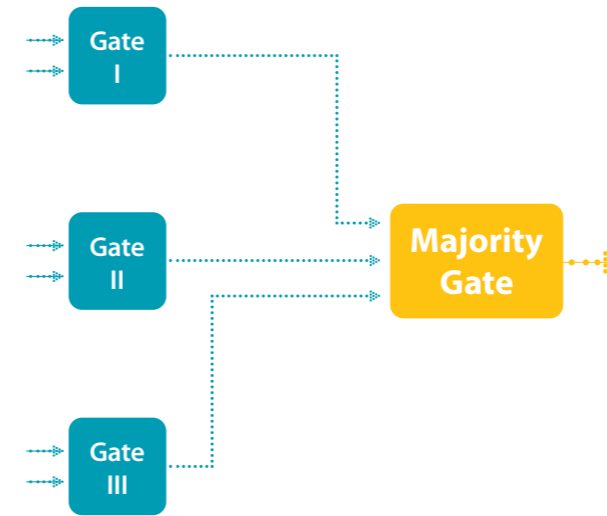

For applications with high safety or reliability demands, redundancy is built in to mask a failing element

KEY FACTORS TO CONSIDER



01

Microprocessors offer high flexibility but have lower performance than dedicated hardware.



02

Dedicated hardware can be restrictive although integrated MCUs now use microsequencers to coordinate them without processor intervention.



03

By splitting and distributing workloads between microprocessors and hardware, performance can be optimised.

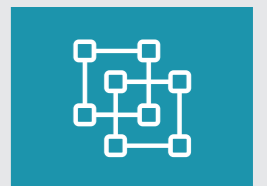

04

Where hardware performance and flexibility are required, FPGAs should be considered.



Software for Robotics

There are multiple levels of software control that need to take place within all but the simplest robots. The microcontroller units (MCUs) and system-on-chip (SoC) solutions responsible for managing sensors and actuators will generally take advantage of a real-time operating system (RTOS) or kernel.

The advantage of using an RTOS is support for multi-tasking. It provides a relatively simple way to schedule numerous activities on a single microprocessor in a way that maximises resources and the ability of the system to react to external events. For example, opening the safety cage needs to trigger a suspension of activities in a way that minimises risk to robot and personnel. Simply removing power is potentially

unsafe. An RTOS can trigger all the actions needed to place the robot in a non-moving state but ensure that it does not drop heavy objects or cause damage to anything else. This can be achieved, for example, by moving to a software thread that orders the power electronics circuits to hold motors in predefined positions.

In combination with appropriately designed applications software, an RTOS can provide hard guarantees of the amount of time it takes to react to critical events, which are normally signalled by an external interrupt to the microprocessor. This is normally handled through an interrupt handler which may initiate a software thread that can take action. Through priority-based pre-emptive scheduling, the RTOS guarantees the shortest possible latency for this type of response to the most important issues.

In a robot with multiple microprocessors and hardware accelerators, which is increasingly the case, each of the actuator nodes needs to be controlled by a supervisory system that takes care of task planning and high-level behaviour. This is a role that is typically undertaken by middleware such as the robot operating system (ROS) running on a high-performance microprocessor.

Today, an ROS is designed to run on an operating system such as Linux rather than being an operating system in its own right. ROS also does not demand RTOS behaviour from the underlying operating system as it is performing longer-term tasks than those that need microsecond response times. However, work is underway to build ROS 2.0 implementations

that will run on RTOS platforms so that they can offer higher degrees of responsiveness.

The middleware that makes up ROS provides a variety of services. They include hardware abstraction of low-level devices, and support for messages passing between processes to enable multi-processor architectures and the management of software packages. Typically, processes are represented using graphs that link nodes to denote where processing takes place and how the processes communicate with each other. ROS implementations are often open-source packages and make use of Linux platforms to ease the job of managing dependencies between open-source projects. This has the benefit of making ROS software easy to access.

In ROS, nodes are processes or software modules that handle one or more related tasks. For example, a camera and image processing node may process visual data from one or more image sensors. To enable the use of networking infrastructure to interconnect nodes – an architecture now common in automotive systems – ROS supports TCP/IP and UDP for message passing. The various nodes and connections can be described using the Universal Robot Description Format (URDF), which is an XML file format.

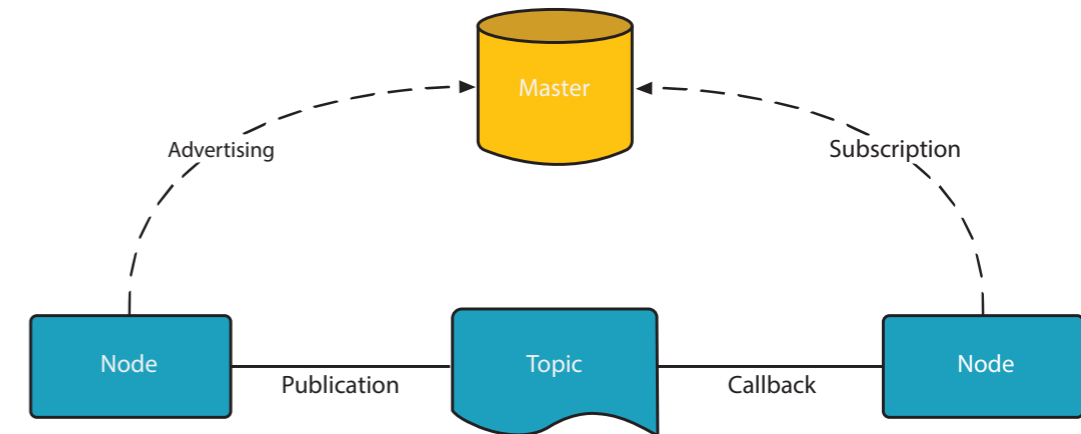

The Robot Operating System (ROS) publish-subscribe mechanism allows nodes to be kept up-to-date on commands or sensor data

To enable efficient sharing of sensor data and commands, ROS employs a publish-subscribe mechanism in which nodes register to be informed of specific topics. Any updates on each topic are sent to all of the subscribed nodes. The ROS Master keeps track of all services and topics. It handles node registration and operates a parameter server to allow nodes to store and retrieve common configuration data.

A major advantage of middleware such as ROS is code reuse and sharing. Code sharing allows all users to have a common base of software, which helps with testing and overall software reliability. ROS is not restricted to physical robots. It also supports simulated robots.

A key requirement of robot design is the ability to simulate its behaviour in the virtual environment before implementation in hardware. The simulator allows for robotics programs to be written and debugged offline. It allows the development of software in a risk-free environment and avoids the problem of damaging the robot or the robot's surrounding environment if the proposed program contains serious errors. The final version of the program can then be tested on an actual robot.

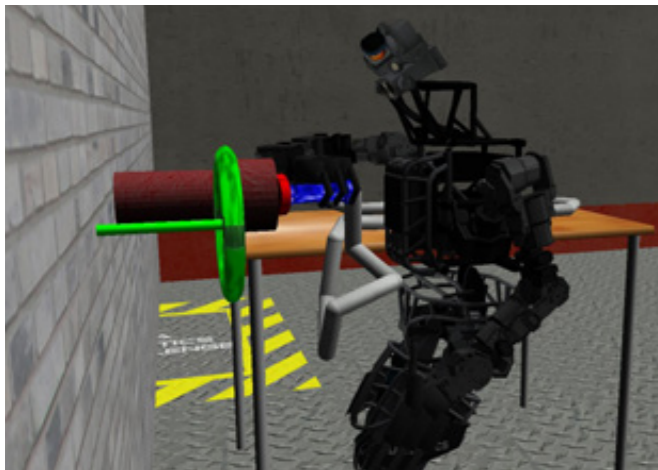

*A simulated image of an Atlas robot connecting a hose to a pipe
(The appearance of U.S. Department of Defense (DoD) visual information
does not imply or constitute DoD endorsement)*

There are further advantages of simulation. Designers can develop in phases, starting with simple high-level models, which is beneficial for complex projects. Such simulations can be used at an early state to establish whether a system is viable. The simulation environments developed for robotics are designed to be compatible with a wide range of programming languages, which supports easy development. And simulation can cut development time as it allows mistakes in application logic to be corrected before they are committed to hardware and so become much more difficult to fix.

There are a number of approaches to robot simulation. Traditionally, simulation was focused on the kinematics of robot movement to demonstrate whether paths and trajectories are feasible and practical.

This type of simulation puts a virtual robot into a 3D space and demonstrates how joints are likely to move in the physical world. The simulation can also help determine whether a robot will be able to lift and manipulate heavy or bulky objects without losing stability.

Some kinematics simulators use a simplified set of calculations and focus primarily on how a program may rotate and move objects to ensure they do not collide with the boundaries of a safety cage or work-cell. Others involve more complex physics simulation to gauge the stresses and other issues that can affect robot performance in the field.

As robots move out of controlled environments protected by safety cages and into areas where people and other robots can move around freely, designers need to take account of possible interactions. For mobile robotics design, simulators that deal with behaviour let designers create, at a high level of abstraction, virtual worlds that contain other objects. A simple

behaviour simulation just takes into account the motion of a robot among a set of fixed objects. More complex simulations involve the use of multiple mobile agents or avatars. These behaviour-based simulators help with the design of applications where the robot is likely to be faced with complex environments. They can learn from collisions and other interactions to better deal with obstacles. Physics simulations are important for establishing that the kinematics of the robot are accurately represented.

Simulation environments such as the open-source Gazebo package can generate realistic sensor data that may be corrupted with varying levels of noise. Gazebo makes it possible to tune simulation to the specific requirements of the application – for example by using different physics engines. A maximal coordinate solver such as ODE or Bullet is often chosen when simulating cluttered environments. A Featherstone-based solver like DART or Simbody will find more applications in articulated systems such as humanoid robots or complex manufacturing robots. All of the physics engines are accessed through the same applications programming interface (API).

There are, however, limits to simulation. An application can only simulate characteristics and events for which it is programmed. Internal or external factors are not represented and will not be simulated, which can lead to problems when the design is translated to hardware. It also is often difficult to build sufficiently representative scenarios, especially when it comes to evaluating complex situations and behaviours. However, experience with translating simulated designs into the physical environment can be fed back into future projects, which will reduce errors as time goes on.

As a result, simulation remains one of the most powerful tools in the armoury of the robot engineer.

KEY FACTORS TO CONSIDER



01

Most readily available robot operating system (ROS) implementations do not run on a hard real-time operating system (RTOS), but the components that provide data to the ROS will often need to be based on an RTOS.



02

Engineers can choose from open-source or commercial offerings for ROS, simulation and RTOS options.



03

Simulation environments cover a variety of needs, from basic motion profiles through physics-assisted kinematics to behaviour in complex scenarios.



AI in Robotics

One of the key problems in robot design lies in providing the machine with an understanding of the world around it. The robot needs to be able not only to detect obstacles and dangers but to understand their nature so it can react to each situation appropriately.

A collaborative robot (cobot) is designed to interact with humans in a shared space and, for example, must be able to differentiate between objects that it needs to pick up and move from the people who may be working alongside it.

Although it is possible to build rules-based models that guide

the motion of an autonomous system, it has proven difficult to engineer these systems to be robust and effective in the complex situations that they are likely to face in applications such as cobots in the factory or warehouse environment, or delivery robots. Machine learning provides an alternative path to achieving a solution. It has been demonstrated in

numerous applications, from drones that can follow paths through a forest, to self-driving vehicles that are reliable enough to be allowed to run in trials on city streets.

The key application for machine learning in robot design is that of perception – providing the robot with the ability to react appropriately to the input from cameras and sensors that image the 3D landscape around it. Sensory artificial intelligence provides the robot with the ability to recognise objects in the surrounding environment. Using that understanding, the robot can use pattern matching to learn appropriate behaviours from past experience. And it may learn new situations as they arise through reinforcement-learning techniques.

AI is becoming more present in our daily lives. Devices like Amazon's Alexa, Google's OK Google and many other web services depend on these complex algorithms, which are run on servers in the cloud. Robot designers will turn to similar approaches both through improvements in hardware performance and the ability to offload some of their processing to the cloud.

Since its inception over 50 years ago, there are now many approaches to the concept of machine learning. The fundamental link between all machine-learning technologies is that they take in data, train a model on that data and then use the derived model to make predictions on new data. The process of training a model is a learning process where the model is exposed to unfamiliar data at each step and is asked to make predictions. Feedback from these predictions in the form of an error term is used to alter the model so that, over time during the training process, the model improves.

Often the model adjustments made for new data will worsen performance on prior samples. So it takes multiple iterations over the training set to achieve consistent performance. Typically, training stops when the predictions of the model reach a point at which the error does not improve – which may be a local or, ideally, a global minimum. As a result,

machine learning has strong links to optimisation techniques such as linear regression in which a curve is fitted to a set of data points.

There are many machine-learning algorithms available. An important distinction is between supervised and unsupervised learning. In the latter case, the model is provided with unlabelled data and asked to segment the elements into groups. A common algorithm used for this purpose is k-means clustering. The algorithm works iteratively to assign each data point to one of a number of clusters. The algorithm does this by first estimating centroids for each cluster – often by an initial random selection – and then refining its model based on the distance between data points from each other until it determines the most likely clustering.

In robotics, k-means and similar unsupervised clustering approaches have been used to support the automated mapping of unknown spaces by groups of robots. However, for perception-based tasks, supervised learning is currently the most common form of machine learning being applied in research and production robots.

Until recently, one of the most successful techniques for image-recognition tasks was the support vector machine (SVM). This technique is similar to clustering but works with data that has been labelled into two or more classes. The job of the SVM is to determine the parameters that will allow the model to place unlabelled data into the most appropriate class. Although SVMs were used in research for applications such as autonomous vehicles in the late 1990s and early 2000s, their use has largely given way to deep learning.

Deep learning is a modification of the artificial neural network (ANN) technology that was highly publicised in the 1980s and 1990s, which itself drew on theories developed more than half a century earlier, which were inspired by the biology of the animal brain. In a traditional ANN design, artificial neurons are arranged in a small number of layers – an input, an output and a hidden layer. Each neuron in the hidden layer takes in data from every neuron in the input layer, performs a weighted sum and applies an activation function, such as the hyperbolic tangent or logistic function, before passing the result to the output layer.

Training of the network is typically performed using backpropagation, an approach to optimisation and error reduction that works from the output back to the input – giving the technique its name. Backpropagation calculates the gradient of the error. This gradient is used to perform gradient descent in an attempt to find a set of weight values that are more likely to reduce the error during each epoch of training. This approach to ANN showed early promise. But the need for intensive computing resources to perform backpropagation and its inability to compete with the SVM meant that ANN slipped into relative obscurity. That situation began to reverse with a reinvigoration of deep networks – ANNs with more than one hidden layer – that were first proposed in the 1960s but which foundered because optimising the network weights proved extremely difficult.

A key development was the application of a more efficient approach to training and backpropagation developed by Geoffrey Hinton and Ruslan Salakhutdinov, working at the University of Toronto in the mid-2000s. The development was aided by the massive improvement in compute performance compared to the early 1990s, first with multi-core CPUs

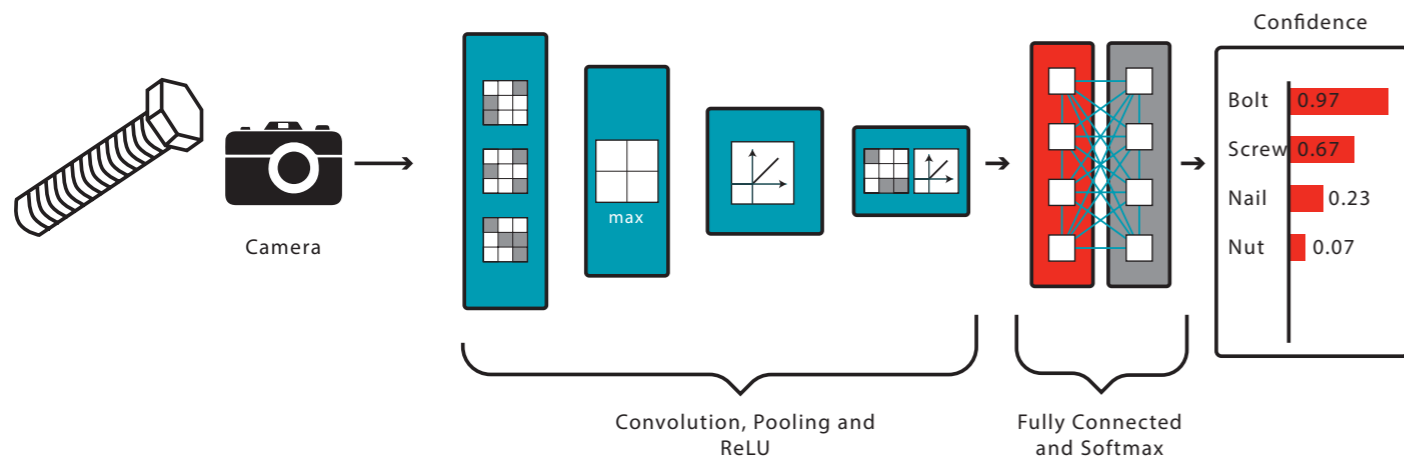

A deep learning platform delivers a statistical likelihood of the object captured by the camera being the desired object, in this case a bolt

and then with GPUs. Increases in model performance came with the application of refinements to the fully connected architecture that had been proposed over the previous two decades. One was to introduce convolutional layers interspersed between fully connected layers.

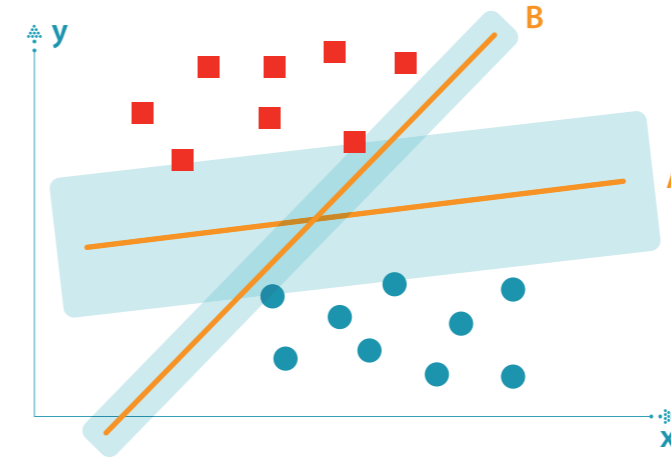

Two possible partitions for a data set that support vector machine (SVM) training might yield

Convolution is a matrix operation that applies a feature map to an array of data – pixels in the case of image recognition.

The feature map can be regarded as a filter. Convolutions of this kind are frequently used in image processing to blur images or to find sharp edges. They also provide a way of converting data in a spatial domain to a representation based on the time domain, where waves are superimposed on each other to form the overall image. As a result, convolutions make it possible to convert pixel arrays into collections of features that can be worked on independently by the following layers.

In contrast to the conventional use of convolution in image processing, the feature maps are learned as part of the ANN

training process. This makes it possible for the model to adapt to differences in the training set that make it easier to distinguish between examples. For example, feature maps tuned to detect differences in shape will be most appropriate for general image-recognition tasks. Feature maps optimised for colour will be favoured in situations where the objects to be separated have similar shapes but are differentiated by their surface attributes.

One major advantage of the convolutional layer is compute efficiency. It is easier to implement in an ANN as it employs far fewer connections per neuron than fully connected layers, and maps readily to GPUs and other parallel-processing architectures with single-instruction, multiple-data (SIMD) arithmetic units. Another attribute of convolutional layers is that the design resembles the organization of neurons in the visual cortex of the organic brain, which is different to the more highly connected regions used for cognition.

Multiple convolutional layers are often used in series in deep-learning architectures. Each successive layer filters the image for increasingly abstract content. In a convolutional neural network (CNN), a set of convolution layers is often followed by a pooling layer. These pooling layers combine the outputs from multiple neurons to produce a single output – producing a sub-sampling effect – that can be fed to multiple inputs in the following layer. This pooling has the effect of concentrating information and steering it to the most appropriate set of neurons that follow. The benefit of their use is that they improve the performance of recognition operations on images where important features may move around within the input. For example, a person's face may move around in the image field as the robot approaches. Pooling layers help ensure that features activated by the shape and colour consistent with those of a face are steered towards neurons that can perform a more detailed analysis. Training on images in which faces are offset and rotated helps build the connections between the most appropriate neurons.

There are different kinds of pooling operations. A max-pooling layer, for example, takes the maximum value from the inputs and passes that on. The highly influential AlexNet entry to the ImageNet LSCVRC-2010 contest employed these structures. AlexNet comprised five convolution layers, three fully connected layers, and three max-pooling stages.

A further improvement to training performance came with the adoption of stochastic gradient descent (SGD) as the mechanism for calculating gradient during backpropagation. This was primarily a choice made for computational efficiency, as it uses a small sub-set of the training data to estimate gradients. However, the random-walk effect of SGD helps move the optimisation towards a good global minimum faster and more frequently than with previous techniques.

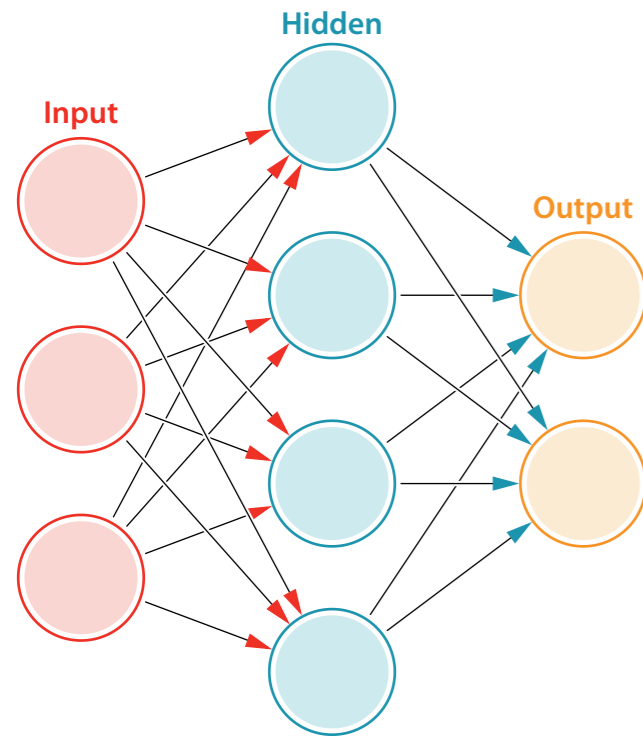

The basic neural network consists of several inputs, a hidden layer, and several output nodes

Not long after deep-learning architectures were first employed, researchers at IDSIA in Switzerland showed that the machines could outperform humans on recognition tasks. In one experiment, the CNN could correctly identify heavily damaged road signs because it was able to make use of visual features that humans would normally ignore. However, this ability to make use of non-obvious features can be a weakness with current approaches based on ANNs.

Poor selection of training materials can cause the network to train on elements that will lead to mistakes in the field.

Researchers have found in recent years that, simply by changing a single pixel in an image, the network will provide the wrong classification. Analysis of the weights chosen by one CNN indicated that, in trying to classify cats, the network had learned to use unrelated markings in some of the training images as part of the identification. Networks will also sometimes claim a successful classification for an image that is only noise.

The architecture of the CNN should be chosen to fit the application. There is no one-size-fits-all architecture. Decisions as to the number and ordering of convolutional, pooling and fully connected layers have a strong impact on performance. And the feature map and kernel sizes for each of the convolutional layers provide trade-offs between performance, memory usage and compute resources.

The classical feedforward architecture of the basic CNN is far from being the only option, particularly as deep learning moves from classification tasks to control. Feedback is becoming an element of the design in applications such as voice recognition. Recurrent neural networks use feedback loops. Memory networks make use of elements other than neurons to hold temporary data that can be used to

store contextual information that is likely to be useful in applications that call for a degree of planning, which may include systems that control robot behaviour and motion. Another option is the adversarial architecture, based on two linked networks. The competition between them helps avoid the risk of a single network making fundamental mistakes. As the technology continues to develop, we can expect other novel architectures to emerge.

Supervised learning is different from the organic experience in that training and execution occur in different phases: the network does not typically learn as it runs. However, in order to ensure the system is able to meet new challenges, it can be important to perform training sessions on recorded data, particularly if the system flags them as situations that led to errors or poor performance.

For control of the core robot functions, reinforcement learning is often employed. This rewards the robot during training for 'good' behaviour and penalises poor decisions. In contrast to simple image-classification tasks, forward planning is a vital component of the process. This calls for the use of discounting techniques to tune rewards for decisions made in a given state. A discounting factor of 0.5, for example, will be just one-eighth of its value after three state changes. This will cause the machine-learning network to pursue near-term rewards. A higher discounting factor will push the network to consider longer-term outcomes.

A key question for designers of robots is where training occurs. The separation of training and the inferencing needed during execution provides an opportunity to offload the most compute-intensive part of the problem to remote servers.

Inferencing can take place in real time using less hardware while servers perform training updates in batches overnight. The cloud environment provides access to standard tools such as Caffe and TensorFlow that can be used to design, build and test different CNN strategies.

With a hardware platform optimised for inferencing, designers can take advantage of some features of CNN architecture to improve processing efficiency. Typically, the backpropagation calculations used during training demand high-precision floating-point arithmetic. This keeps errors to a minimum. The processes of normalisation and regularisation work to reduce the size of individual weights on each neuronal input. These steps are needed to prevent a small number of nodes developing strong weights that reduce overall performance.

As a result of normalisation, some weights will reduce to very low levels and, in the optimisation process, reduce to zero. In the runtime application, these calculations can be dropped entirely. In many of the interneural connections with low significance, the weighted-sum calculation can tolerate increased errors from the use of low-precision fixed-point arithmetic. Often 8-bit fixed-point arithmetic is sufficient. And, for some connections, 4-bit resolution has been found to not increase errors significantly. This favours hardware platforms that offer high flexibility over numeric precision. A number of microprocessors with SIMD execution units will handle low-precision arithmetic operations in parallel. Field-programmable gate arrays (FPGAs) provide the ability to fine-tune arithmetic precision. An upcoming generation of coarse-grained reconfigurable arrays (CGRAs) optimised for deep learning will provide an intermediate solution between microprocessors and FPGAs. They will help improve performance and make AI-enabled robots and cobots more feasible.

KEY FACTORS TO CONSIDER



01

Machine learning provides a way of building more advanced sensory and control systems for robots compared to traditional path- or rule-based control strategies.



02

Use an appropriate machine-learning algorithm. Deep learning is not necessarily the right answer for all situations.



03

Training and inferencing are separate processes. This can be leveraged by offloading the more compute-intensive operations to the cloud.



04

CNNs can be deployed in many forms. The architecture of the CNN is intimately tied to the type of data it is expected to learn and process.



05

Training data quality is vital. Poor selection of training data can lead to unexpected results.



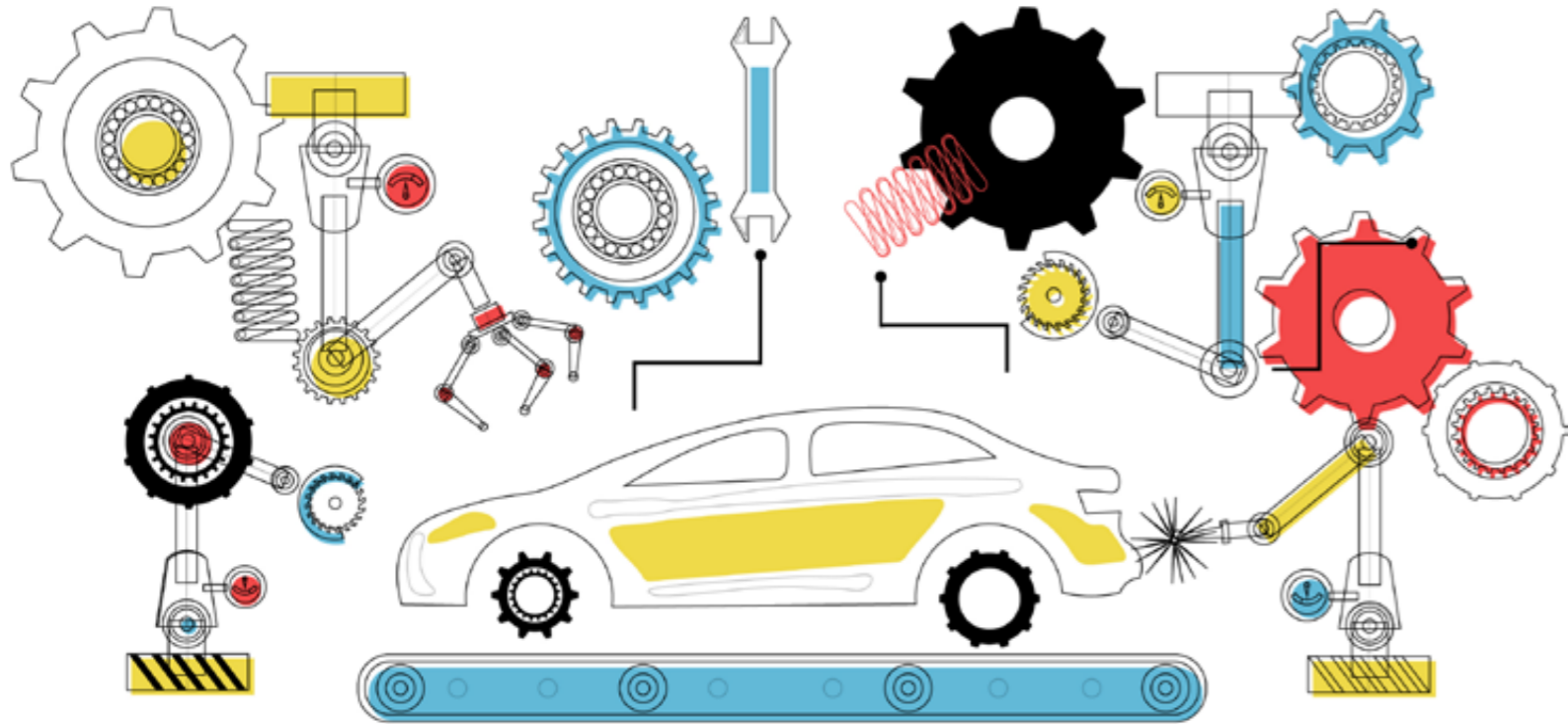

Effectors

A robot's primary means of interaction with its environment is the effector. The effector is controlled by the robot and can be in the form of wheels, fingers, a tool or any physical construction that makes the robot act within its working envelope.

Effectors are among the most important, most customised parts of any robot, and the robot's purpose defines the requirements for the effector, or effectors.

In industrial robotics the end effector is typically either a gripper or a tool. Here the common effector types and their applications and design considerations are described.

BASIC CONCEPTS

In order for actuators to perform a physical movement in an environment an effector is needed to transform (electric) energy into movement. Most simple actuators only control one degree of freedom (DOF), typically linear or rotational.

The task the robot needs to perform defines the system requirements for the effector and, indirectly, the DOF needed. The greater DOF an effector has, the more sensors are needed and the more complex the required programming becomes.

The DOF of a robot can be considered a system constraint. The DOF number of the overall system includes the DOF of the robot plus the additional DOF of the effector. Yet most effectors only add a single DOF to the overall system.

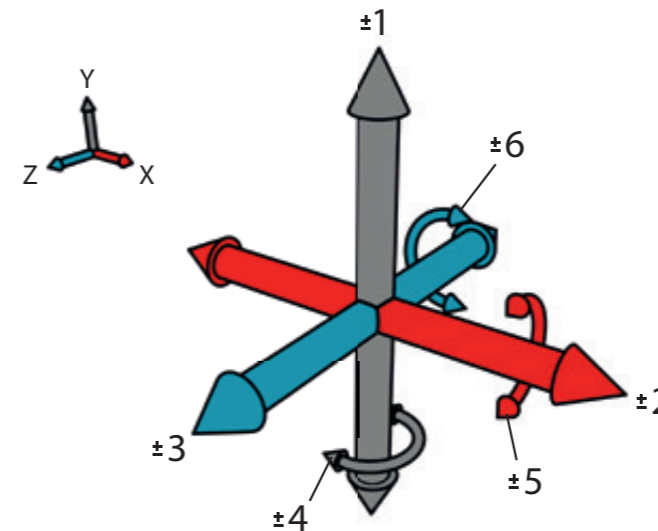

The degrees of freedom (DOF) of an effector defines how flexible it will be in tackling the task at hand

GRIPPERS

The most common effector types in robotics are grippers. Grippers are end effectors that aim at picking, holding and placing an item. Grippers can be unilateral or multilateral, which refers to the number of contact points between the gripper and the target object. There are four general categories of robot grippers:

- **Impactive** – mechanical jaws that use form closure or force closure
- **Ingressive** – pins or any other construction that penetrates the surface of the object (often used for textile and CRFP handling)
- **Astrictive** – suction by means of vacuum, magnetism or electroadhesion
- **Contigutive** – adhesion through direct contact using glue or surface tension

Impactive (mechanical grippers) apply the principle of force closure or form closure to pick and hold items. Force closure grippers are typically multilateral, while form closure grippers can be unilateral.

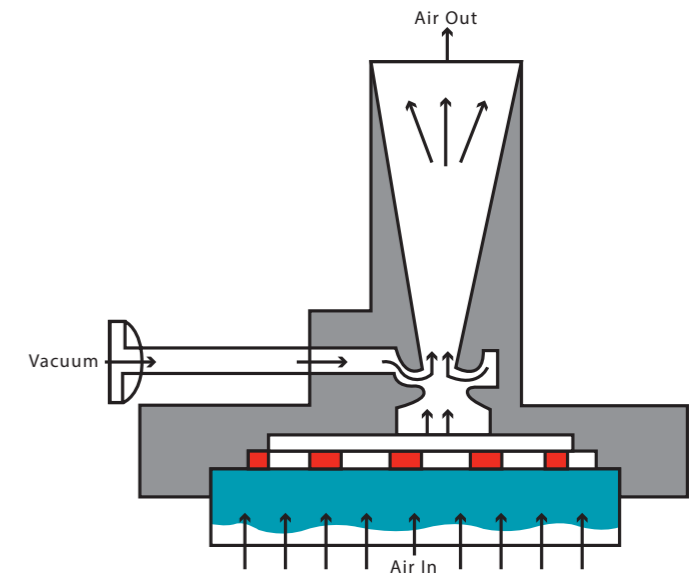

Suction cups are well suited to handling objects with planar surfaces, such as glass

The actuation of those mechanical grippers can be divided into four different mechanisms, all of which require only one actuator:

- **Linkage actuation** – via joints and linkage the lateral movement is transformed, making the grippers close
- **Gear and rack actuation** – a lateral movement is transformed into two counter-rotating rotational movements, shifting the gripper together
- **Cam actuation** – a conical shape is shifted between two ends of a gripper that are fixed, allowing for rotation
- **Screw actuation** – rotational movement is transformed into lateral movement

Mechanically actuated grippers are typically actuated with the means of an electric motor or servo. Other sources of actuation could also be pneumatics or hydraulics, where the source of the activation would come from a cylinder that provides linear movement, which is then transformed into the necessary final movement using linkages.

Types of astrictive grippers include suction and vacuum grippers. These are typically of unilateral nature, meaning they only create one point or surface of contact. They are mechanically rather simple but must be customised according to their specific application.

Suction cups are used to lift objects with simple, mostly planar, surfaces. The suction cup is evacuated of air during the time the object should be bound to the gripper. When the object has to be released or placed, air valves are opened to release the vacuum.

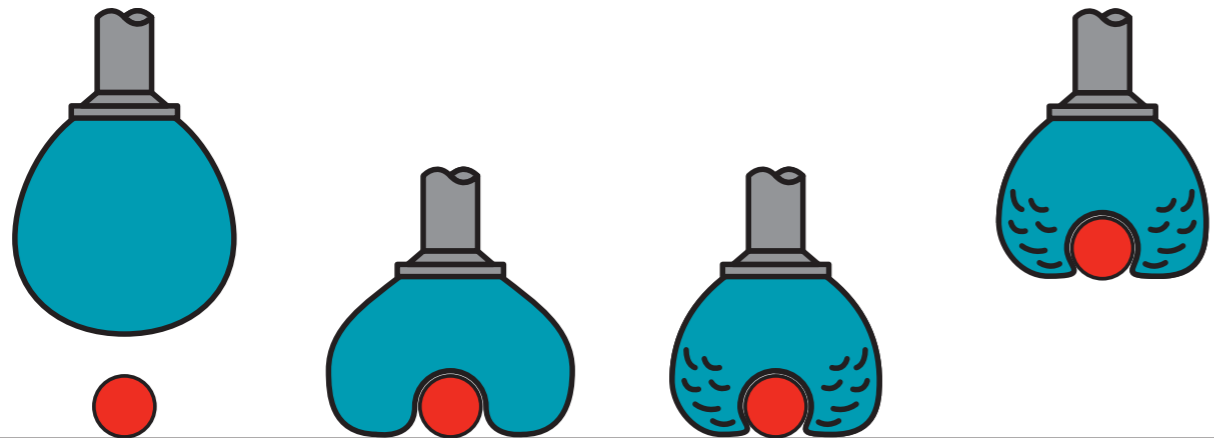

gripper approaches in soft state → gripper deforms around object → air is evacuated from gripper → object can be manipulated

Soft and deformable vacuum grippers can handle a variety of objects

Simple astrictive grippers include adhesive grippers which use only one contact surface, with the advantage that no constant suction is needed to maintain the adhesion. Instead, only lightweight materials can be lifted, and the gripping reliability obviously diminishes over cycle time.

Another concept of grippers with a more universal use is the soft and deformable general-purpose vacuum gripper. This concept can be considered a hybrid between impactive and astrictive. A deformable spherical shape filled with granular material is placed over the object to be lifted. The gripper shape deforms and wraps around the object and then air is evacuated from the gripper head. This makes the gripper head stiff and creates an almost perfect form closure, so the object can be lifted.

TOOLS

Among the most commonly used industrial end effector types are welding torches. Formerly welding robots were general-purpose industrial robots with a high payload capability that were equipped with a welding torch as end effector. But with the increased demand for welding robots, manufacturers have developed distinct welding robot systems that are smaller and cheaper.

Other types of tools for end effectors include power wrenches, drilling modules and rivet fasteners to name a few.

For production areas where maximum flexibility is required a multi-function end effector (MFEE) can be used. Such MFEEs offer many of the tools mentioned above in one unit, but this comes at a price in terms of volume, weight and general sturdiness.

Depending on the task, a robot head can simply consist of a set of sensors. A robot's head repeatability and accuracy make it ideal for product quality inspection. For example, a camera head with additional laser sensors can check a product for the correct dimensions and surface finish, whereas 3D scanners can measure and digitise the full-size object.

SENSORS

Sensors play a very important role in robotics. But apart from the sensors that are built into the robot, the effectors often come with their own set of sensors that are essential for the robot to safely and accurately perform its tasks. The most commonly used sensor is the 'force torque sensor'. As the name suggests, this device is able to sense forces in all three axes and torque on all three axes. This makes the FT sensor (as it is commonly known) a sensor for all six DOF. The FT sensor is typically placed between the end effector and the wrist of the robot. This way the FT sensor can accurately measure the force exerted on an object.

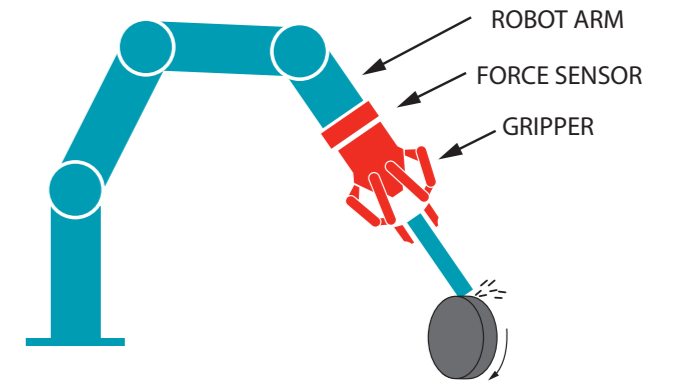

Force torque sensors enable robots to handle tasks previously only possible by humans, such as deburring and grinding

CONCLUSION

The most commonly used end effectors are grippers. As the requirements for grippers vary with the shape and nature of the object that has to be collected, grippers are often highly customised. Other end effectors are specific or multi-purpose tools for drilling, welding, screw fastening, grinding, to name a few. As the role robots play in production processes attains more importance, robot manufacturers are likely to focus on developing application-specific robots that are cheaper and lighter as opposed to general-purpose robots with customised effectors.



The Future of Manufacturing and MRO

How we go about manufacturing has changed beyond recognition in the last 100 years. Row upon row of unskilled workers soldering bases for light bulbs, as was the case at Osram in Berlin in the 1920s, is a thing of the past.

And the incandescent light bulbs they produced have also been consigned to the history books, having been replaced by electronically controlled LED lighting systems – a complex integrated solution requiring multiple processing steps,

a completely different chain of supply and a multitude of complex on-site and off-site machines for their manufacture. As a result, the role of the plant's engineering manager and their maintenance team has changed significantly, as has

the number of interfaces to other teams and groups within the organisation. At the same time, economic factors and globalisation have forced businesses to tackle the thorny issue of investment at home compared to outsourcing. Recognition of these challenges has been taken seriously by various nations, with the government in Germany going as far as developing the 'Industrie 4.0' campaign, something that has resulted in a number of initiatives to support their industrial base to remain competitive with low-wage countries through the facilitation of digitalisation.

At the heart of any manufacturing operation is a maintenance, repair and operation (MRO) plan. Such plans are designed to ensure optimal manufacturing throughput

by careful planning of preventative maintenance (PM) such that it doesn't disrupt the manufacturing flow. As well as keeping the factory productive, a well-executed PM plan can ensure that a robot remains productive for up to 20 years, thus improving the return on investment (RoI). FANUC, the Japanese factory automation specialist, recommends planned PM every 3,850 hours (~160 days) or 12 months, whichever occurs sooner. In comparison, KUKA, the Chinese-owned German manufacturer of robotic systems, specifies 10,000 hours (~416 days). The maintenance programme includes various activities, from backing up of controller memory and optical inspection of parts, cables and harnesses, to checking of repeatability and greasing joints (see below).

- Back-up controller memory
- Optically inspect robot in motion, its harnesses and cables
- Inspect brake operation
- Check repeatability
- Listen for excessive audible vibration/noise during operation
- Grease joints, replace oil (may require physical analysis)
- Visually inspect 'teach pendant' and control cables
- Visually inspect connectors, cooling fans, PSUs and safety equipment
- Test/replace back-up RAM and UPS batteries
- Plan visit from supplier's service team

This checklist highlights some of the key maintenance items for a robotic system

In addition, correct configuration and training of operators is imperative to ensure that failures and breakdowns do not occur unexpectedly outside of the PM schedule.

Tool and load weights need to be correctly entered to ensure that the robot system understands the constraints within which it is operating. Some systems can estimate the weight themselves, but it still remains best practice to weigh the tool and load with appropriate scales and enter the values manually. Additionally, correct configuration of the duty cycle should ensure that each movement uses the full time available, rather than simply setting the system to move between each set-point as quickly as possible. This ensures that the power electronics, motor and gearbox are not unduly overloaded, which would cause unnecessary extra wear.

Finally, operators and the maintenance team should ensure that halting of the robot is undertaken using the manufacturer's provided mechanism, typically a halt button, rather than using the emergency stop or triggering of safety interlocks. The emergency stop mechanism will engage the braking system, causing early wear, which typically results in a loss of repeatability, or creep, over time.

Planning for unforeseen issues, such as breakdowns and disruptions, ensures that these can be tackled in the minimum amount of time, should they occur. Sourcing of quality replacement parts and keeping them in stock can be part of the solution. However, many suppliers offer the ability to schedule orders or even provide consigned stock, helping to reduce the risk, keep costs down and ensure that down-time is kept to a minimum in the event that something goes wrong. In today's world of the connected supply chain, it is therefore advisable to carefully review stocking of spare parts and materials.

When considering risks to the supply chain, it must also be considered that even countries that were considered stable (such as Great Britain prior to its decision to Brexit), and companies that were thought to be too big to fail (such as Hanjin prior to its bankruptcy), cannot simply be ignored as potential risks any more. If anything, we have learned that changes beyond our control really can happen any time, anywhere. In addition, suppliers with manufacturing in countries impacted annually by extreme weather, or at risk of earthquakes, need to be risk-assessed. As the savings associated with lean manufacturing programmes become depleted to the point that the implementation costs outweigh them, it is clear that more automation, and therefore more equipment, will be added to the manufacturing mix.

As a result, there is an increase in robotic machine tending, where robots are used to handle the insertion and retrieval of worked pieces for up to five machines. Such robots can also handle visual inspections, perform barcode verification and even label products. Further added value over human operators is also delivered through repeatability, as a robot is able to perfectly position the piece of work each time. This results in higher quality for the parts produced, as well as a reduction in rework. Even tasks thought to require the human touch can nowadays be handled by robots, such as welding, grinding, deburring and polishing, as the addition of force-feedback has put such tasks within robotic reach. Robots are increasingly capable of handling task-to-task variability, which is increasing the number of tasks for which they can be used. The ultimate aim of automation is not always process improvement and cost savings at the expense of jobs. BMW, known for its premium motor vehicles, has integrated around 20,000 robots and 250,000 control systems across its 31 manufacturing locations, while the number of employees has remained constant. Additionally, analyses undertaken by the Boston Consulting Group have shown that investment in automation in existing manufacturing locations, along with benefits such as retaining knowledge and IP in-house, and maintaining

control over the supply chain, can result in the same cost savings as the alternative: outsourcing.

Therefore, whether we like it or not, increases in automation and the rollout of digitalisation are changes we should embrace. Activities that fall under the banner of Industry 4.0 and the Industrial Internet of Things (IIoT) will become increasingly critical to the next wave of optimisations and improvements in production facilities, as well as providing insights earlier into the state of manufacturing equipment. The reason these terms still seem so vague is that, with such a diverse set of needs across the industries where they are used, there is rarely an off-the-shelf solution available. Instead, a combination of existing technologies, new solutions and some customisation are required. The insights such technologies bring will enable engineering managers and their teams to schedule extra maintenance when required in a manner that has less impact on production flow, reducing the likelihood of breakdowns and the associated delays and costs.

Inevitably, discussions around Industry 4.0 or the IIoT lead to the use of cloud services, web applications and services that run on off-site servers.

Quickly, the discussion moves onto issues of data security, IT integration and protection of intellectual property. The reality is, the benefits of a move to deeper digitalisation outweigh the risks, but only with the appropriate support and guidance. First, most IT divisions are focused on up-time, provision of networked storage, network accessibility and user support. The world of automation, with its strict real-time demands and, with many networked machines and sensors, masses of data, will most likely demand restructuring of the IT provision in many organisations. Cross-disciplinary working is, therefore, a must in order that the demands of the manufacturing environment are understood, while the

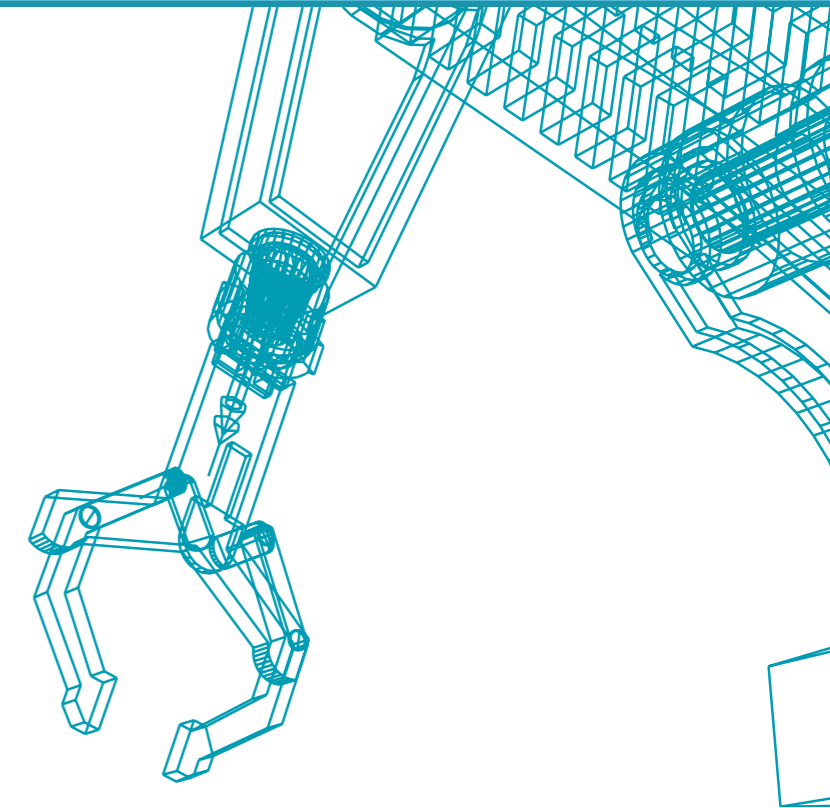

constraints of IT infrastructure are also recognised. Second, IT security experts will also need to be consulted as security has to be an integral part of any system, built-in during development, not as a bolt-on afterthought. With their help, risks can then be appropriately assessed from the system level down, and the implementation can be developed accordingly. Finally, third-party cloud services suppliers often have roll-over strategies in place and can provide guidance on service levels, location of data storage and security. As more and more businesses consider and implement such upgrades, their role is increasingly becoming that of a consultant and partner rather than an inert supplier. For the decision makers and management driving such change, much courage is demanded, along with a healthy portion of trust, together with solid leadership in order to bring employees, suppliers, partners and consultants together and aligned behind the ultimate goal.

For those with deeper pockets, the demonstration manufacturing location for Trumpf in Chicago in the US state of Illinois provides an idea of what a ground-up approach to Industry 4.0 might look like.

With a price tag of around €26 million, the site provides insights into the future of sheet metal forming, housed in 5,500 m² of manufacturing space. Its primary purpose is to advise customers how a fully networked factory of machines can be implemented, while also doubling as a training ground for those getting started in the world of the smart factory. Completing the futuristic feel is the control centre that overlooks the shop-floor, with large displays providing

real-time performance indicators, and a see-through, touch-enabled OLED display with graphics to match those of a science-fiction spacecraft.

In contrast, Osram's 300 m² facility for the production of its Xenarc range of headlamps has been through a controlled and continuous process of digitalisation. After years of successful continual improvement process (CIP) implementation, the point of diminishing returns was being reached. This led to a cooperation with Bosch Software Innovations who had created a user-driven platform that allowed the user to develop the programs they needed without needing to learn to be programmers themselves. Coupling data from SAP with that of 80 manufacturing machines, the employees, from machine operators to service engineers, are able to schedule servicing, order materials and consumables, and deal with malfunctions. How these tasks are handled is defined by rules that the team are able to

program themselves, allowing them to improve and optimise their working environment on a daily basis as they see best. The networked manufacturing machinery is also made up of a mix of older equipment along with equipment that has been custom-designed for specific processes, showing that an upgrade to a smart factory is as attainable as starting from scratch.

The final field to watch in the coming years is that of artificial intelligence (AI). Although it may seem to be driven by hype, the reality is that the technology is highly suited to the challenges faced in the world of manufacturing. AI is exceptional at recognising patterns. With sensors of different types fitted to machines and robots, AI-based systems can be trained to recognise how a fully functioning, newly installed or serviced machine operates. As wear and tear take their toll, even small changes in temperature, vibration, power consumption or noise could help detect early failure in gearboxes, lubrication, motors and seals. In fact, AI is more likely to discover such latent failure than a human reviewing charts and reams of data, as it is ideal for detecting minute differences in patterns from large quantities of data that are challenging to relate with one another, such as vibration and temperature. One key challenge to be overcome is that of data quantity and real-time analysis, as additional sensors will lead to enormous quantities of data being generated, while real-time response to a failure pattern cannot wait until a response returns from a cloud service. The term 'fog computing' is likely to become more common, referring to the idea that cloud services, with their enormous computing power, will be complemented by locally placed servers and embedded computers, perhaps allowing local AI-enabled systems to react quickly, while unlimited-capacity cloud computing concentrates on the collected data's longer-term trends and storage of historical data.

After years of lacking clarity on what Industry 4.0 and the IIoT really means, a handful of organisations have shown the courage to implement tightly digitalised automated

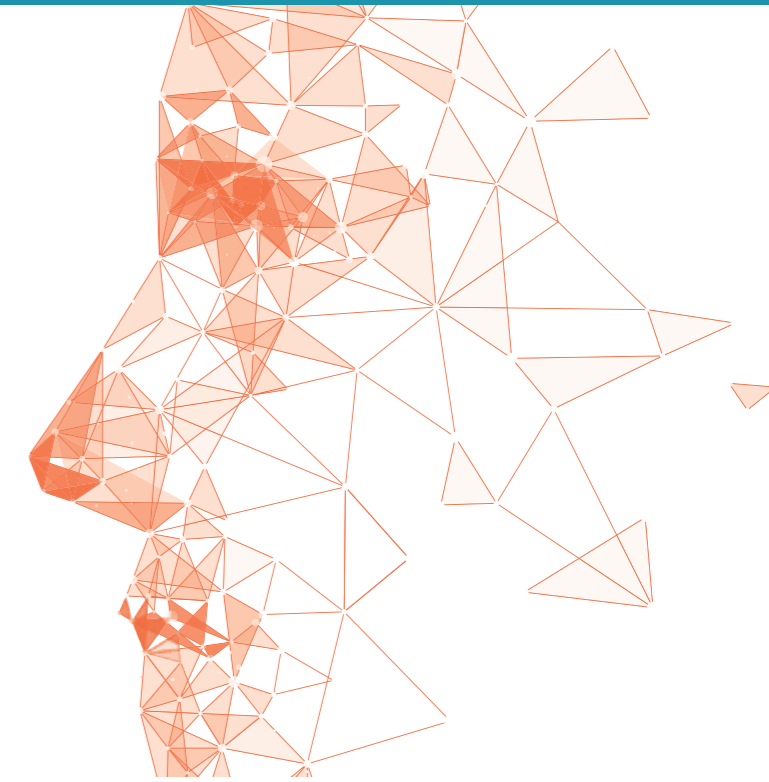

manufacturing. As a result, suppliers of manufacturing machines, those delivering cloud services, and experts in IT security have worked in cross-functional teams to demonstrate that this approach not only works, but also adds value. For many in the industry, this will change the face of maintenance, repair and operation (MRO) strategies, resulting in activities and roles that will disappear, as well as new ones that will take their place. Multi-disciplinary skills will be imperative in ensuring that these are successfully introduced and deliver the expected outcomes. It is also highly likely that AI will make its way into such approaches, resulting in the need to review Industry 4.0 strategies and architectures along the way. But by drawing on courage and years of experience in our areas of specialism, such changes in how we work and interact with the machines around us should enable us to avoid outsourcing, thus enabling us to maintain the quality of our products and retain our reputations.

The Trumpf Smart Factory in Chicago displays what Industry 4.0 can achieve (Source: Trumpf © 2018)





What Does the Future Hold for Robotics?

According to the 2017 report by the International Robotics Foundation, the global robotics market is expected to grow at a CAGR of 15% during the period 2017 to 2022.

Whereas the manufacturing sector is currently the biggest purchaser of robots, future growth will come from 'service robots', in part driven by the number of new start-ups, currently accounting for around 29% of all robot companies.

ISO 8373 defines a 'service robot' as a robot 'that performs useful tasks for humans or equipment, excluding industrial automation applications'. According to ISO 8373, service robots require 'a degree of autonomy', or the 'ability to perform intended tasks based on current state and sensing, without human intervention'. The growth in service robots is based on the emergence of the collaborative robot, or 'cobot', which in turn has been enabled by innovations in sensor technology and artificial intelligence. There have been huge advances recently in deep learning, a branch of AI involving building artificial neural networks which attempt to mimic the way organic (living) brains sort and process information. Deep learning is driving innovation at the cutting edge of AI and it can be seen in many applications today, including speech and image recognition.

Healthcare and process manufacturing are high-growth sectors in robotics, with healthcare spending on robotics expected to double between now and 2019. Medical diagnostics is one particular field where AI is enabling rapid advances, with applications including the following:

- **Chatbots:** Companies are using AI chatbots with speech recognition capability to identify patterns in patient symptoms and make a potential diagnosis.
- **Oncology:** Researchers are using deep learning to train algorithms to recognise cancerous tissue at a level comparable to trained physicians.
- **Pathology:** Pathology is concerned with the diagnosis of disease based on the laboratory analysis of bodily fluids such as blood and urine, as well as tissues. Machine vision

and other machine-learning technologies can enhance the efforts traditionally left only to pathologists with microscopes.

- **Rare diseases:** Facial recognition software is being combined with machine learning to help clinicians diagnose rare diseases. Patient photos are analysed using facial analysis and deep learning to detect phenotypes that correlate with rare genetic diseases.

Service robots are also having a significant impact in areas such as agriculture, surgery, logistics and underwater applications, and the maintenance, security and rescue market.

This section examines the emerging developments in robot technology and the future applications that will be enabled by this. The impact of these innovations on our economy, our society's values and our day-to-day life are also considered.

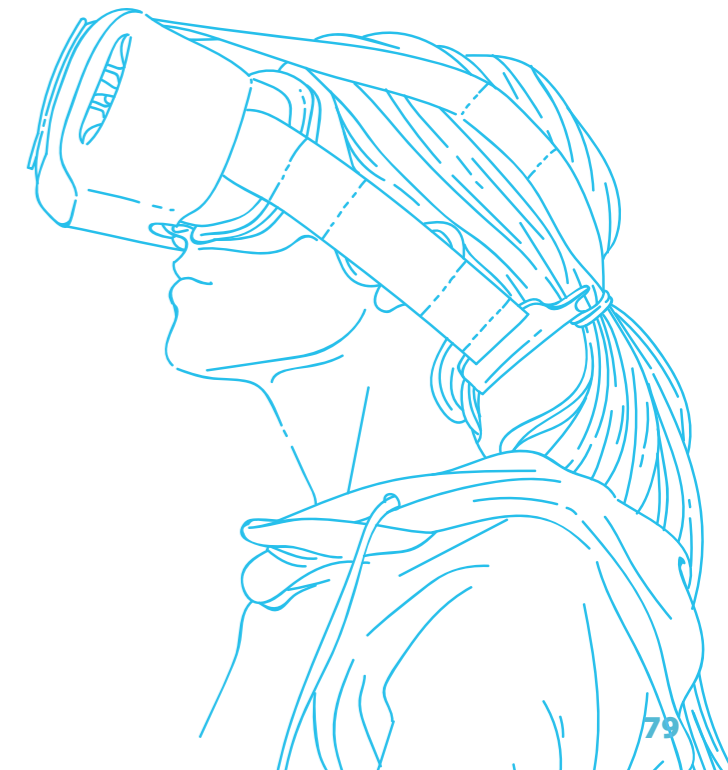

TECHNOLOGY INNOVATION

In recent years there have been record investments into global robot development funds, with Bank of America Merrill Lynch estimating an increase from \$5 billion to \$8 billion in the 12 months to April 2017. Figure 1 shows the trend in patent applications by main market, a proxy for the level of

R&D in these regions. Although Europe currently lags behind, efforts are being made to catch up, with investments in the SPARC joint venture expected to reach €2.8 billion, and many of the European member states announcing their own national programmes.

Total robotic patent applications by location

Number of patents submitted ('000)

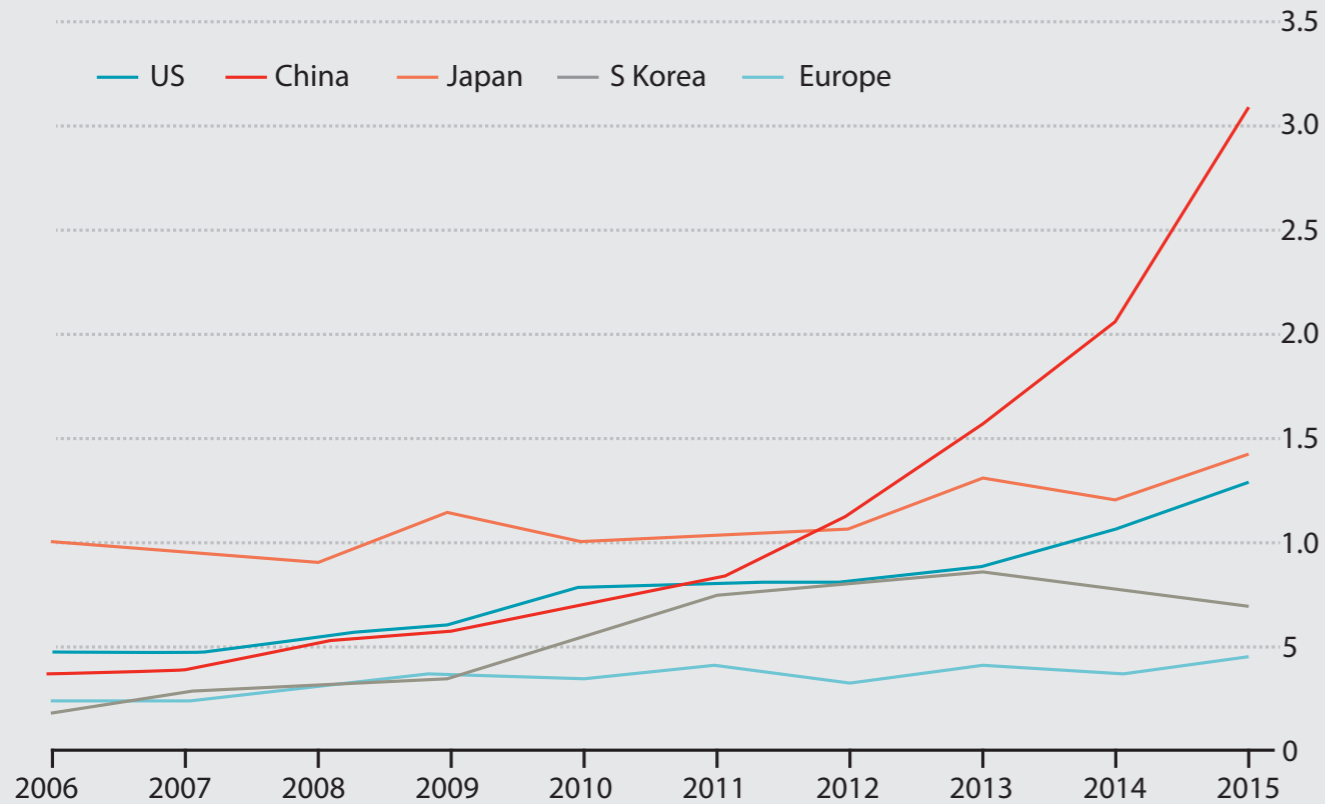

Figure 1: Patent applications for robotic applications continue to grow, with rapid growth seen in China of late (Source: FT)

In the UK, for example, the government has announced a number of initiatives aimed at fully exploiting the country's potential in the global robotics market. In November 2016 Prime Minister Theresa May pledged to increase R&D spend by £2 billion per year on robotics and AI considered central to the government's Industry 4.0 strategy. As part of this overall initiative, £45 million is being used to set up four new research hubs based at the universities of Manchester, Birmingham, Surrey, and Heriot-Watt University in Edinburgh. These establishments will be responsible for developing robotic technology to enable safer working environments in space and deep mining, and the hazardous and harsh environments of nuclear energy and offshore wind. A further £52 million in funding will be provided by commercial and international partners, with the UK Space Agency co-funding the University of Surrey hub.



In Germany 'Industrie 4.0' is one of ten 'Future Projects' outlined in the government's new High-Tech Strategy, to which it has contributed around €200 million. This funding supports a deep base of academic researchers, with projects covering most areas of robotics innovation. Over a dozen major academic institutions are now engaged in various aspects of robotics research, including the Institute of Robotics and Mechatronics, a branch of the German Aerospace Center. The Institute is developing various types of robot, designed to operate in areas that are inaccessible or dangerous to humans, as well as to support humans in their everyday lives and work. Another German research facility leading the way in robotics is the DFKI Robotics Innovation Center, which also focuses on technologies for various challenging and dangerous environments, including space and underwater, as well as safety, mobility and cognitive robotics.

PROJECTS, APPLICATIONS AND ENABLING TECHNOLOGIES

A growing number of companies, both start-ups and established players, are developing service robots, with applications across a number of industries. Medineering GmbH, a start-up based in Munich, has developed a collaborative robotic concept that specifically targets the needs of surgeons. Today, surgeons often require the support of a sufficiently trained assistant to position and hold instruments during surgical interventions. The Medineering solution consists of an easy-to-guide Positioning Arm with a mechatronic interface at its end, allowing a variety of surgical robots to be attached to it. The first robot Medineering offers is an Endoscope Guidance Robot, which holds the endoscope during endo- and transnasal interventions.

The Positioning Arm, with its seven joints, can be positioned exactly as required using the touch buttons on its surfaces.

Once in place, the position can be saved. Fitted to the end of the arm is the Endoscope Guidance Robot, which is then controlled by the surgeon using a foot pedal during the operation. The robot is designed to make fine movements of low intensity, enabling tremor-free positioning and accurate avoidance of sensitive tissue.

This approach relieves the surgeon or assistant from the task of holding the endoscope, so that surgical resources can be used more efficiently. This reduces the time of such interventions or releases medical support staff for other duties, which leads to cost savings. The Medineering Positioning Arm is also open for approved partners to develop further surgical robots to be fitted, making it useful in other areas of surgery.

In the field of hazardous environments, Forth Engineering Ltd's prototype robot has been developed to address a critical issue concerning the treatment of nuclear waste at the Sellafield nuclear site in Cumbria. Forth is collaborating with the University of Manchester to leverage the university's

The Medineering GmbH Positioning Arm and Endoscope Robot enable a surgeon to operate alone, freeing up medical staff for other activities (Source: Medineering GmbH © 2018)



world-leading research in nuclear waste management while developing its robotic 'spider'. The 'spider' is actually a six-legged robot, about the size of a coffee table, and bristling with cameras and sensors, enabling it to see its environment. A large front-mounted pincer grabs and breaks up contaminated material. The robot can crawl up walls using magnets on its feet, and AI software allows a team of the robots to work autonomously, communicating with one another and making their own decisions on how to best complete a task.

Industry 4.0 has been termed the next phase of the Industrial Revolution, characterised by the 'smart factory', in which cyber-physical systems monitor the factory processes and make decentralised decisions.

Collaboration – inter-robot and between robots and humans – is a key enabler of the smart factory, allowing people and robots to each contribute their unique strengths: people providing insight and improvisation, and robots offering speed and repetition.

Retailer Ocado's prototype ARMAR-6 robot is an example of this type of collaborative robot, or 'cobot'. ARMAR-6 has been developed with support from four European universities. The robot has a human-looking torso, arms with eight degrees of freedom, hands that can grip and a head with cameras inside. Designed to help engineers fix mechanical faults in its factories, ARMAR-6 uses a three-camera system inside its head to help it detect and recognise humans and objects. Speech recognition helps it understand commands and its hands are able to pick up and grasp objects. The ultimate goal is for the robot to be able to decide what the technician's intentions are and contribute as appropriate at the right point in time.

ETHICAL AND MORAL CONSIDERATIONS

Advances in AI and robotics have rekindled two long-standing fears: that machines will cause mass unemployment, and that there will be a *Terminator* scenario in which robots will 'wake up' and do unintended things.

A fierce debate is underway with concerns expressed by, among others, the late Stephen Hawking and Elon Musk, the technology entrepreneur. The more optimistic viewpoint is that throughout history technology has created more jobs than it has destroyed, albeit with some disruption to society, such as the migration of jobs to the cities during the Industrial Revolution.

As ever the truth will probably lie somewhere in between. While AI may not cause mass unemployment, it will certainly create disruption in the labour markets, requiring workers to learn new skills more quickly than in the past. This view is supported by a recent study on the German economy, which has shown that employees in operations deploying robots tend to keep their jobs and benefit from upskilling. At the same time these operations have reduced the number of new hires, leading to a shift in employment away from manufacturing and into other sectors.

A recent report from Citi, produced in conjunction with the University of Oxford, has highlighted the risk of increased automation leading to greater inequality as AI impacts on traditional blue-collar jobs more than white-collar jobs. This highlights the important role of companies and governments in making it easier for workers to acquire new skills and switch jobs as needed. Citi identifies investment in education as

the single biggest factor that could mitigate the impact of increased automation and AI.

As with any tool, AI has the potential to be used in both benign and sinister applications. While deep learning has the potential to fight crime it can also allow authoritarian governments to spy on their citizens. Self-driving cars raise other ethical issues, particularly when it comes to how they should behave in emergencies – should the vehicle risk injuring its occupants to avoid hitting a child who steps out in front of it?

It was questions such as these that led to the setting up in 2012 of a two-year, \$2.3 million project called RoboLaw, largely funded by the European Union. Consisting of experts in areas such as law, engineering, philosophy, regulation and medicine, the outcome of the project was a recommended set of guidelines for the regulation of robotics.



ARMAR-6 collaborates with people in its surroundings, supporting them with maintenance work (© 2018 All rights reserved. Ocado)

CONCLUSION

Rapid advances in AI supported by a surge in investment have contributed to a growth in the number and types of robotic applications. Service robots are set to play an increasingly important role in our day-to-day lives, facilitated by their flexibility and enhanced decision-making capabilities.

With analysts and commentators divided on how these developments will impact on our society, the consensus is that conscious intervention is required from governments to regulate and manage the disruption to labour markets which will be caused by this technology.

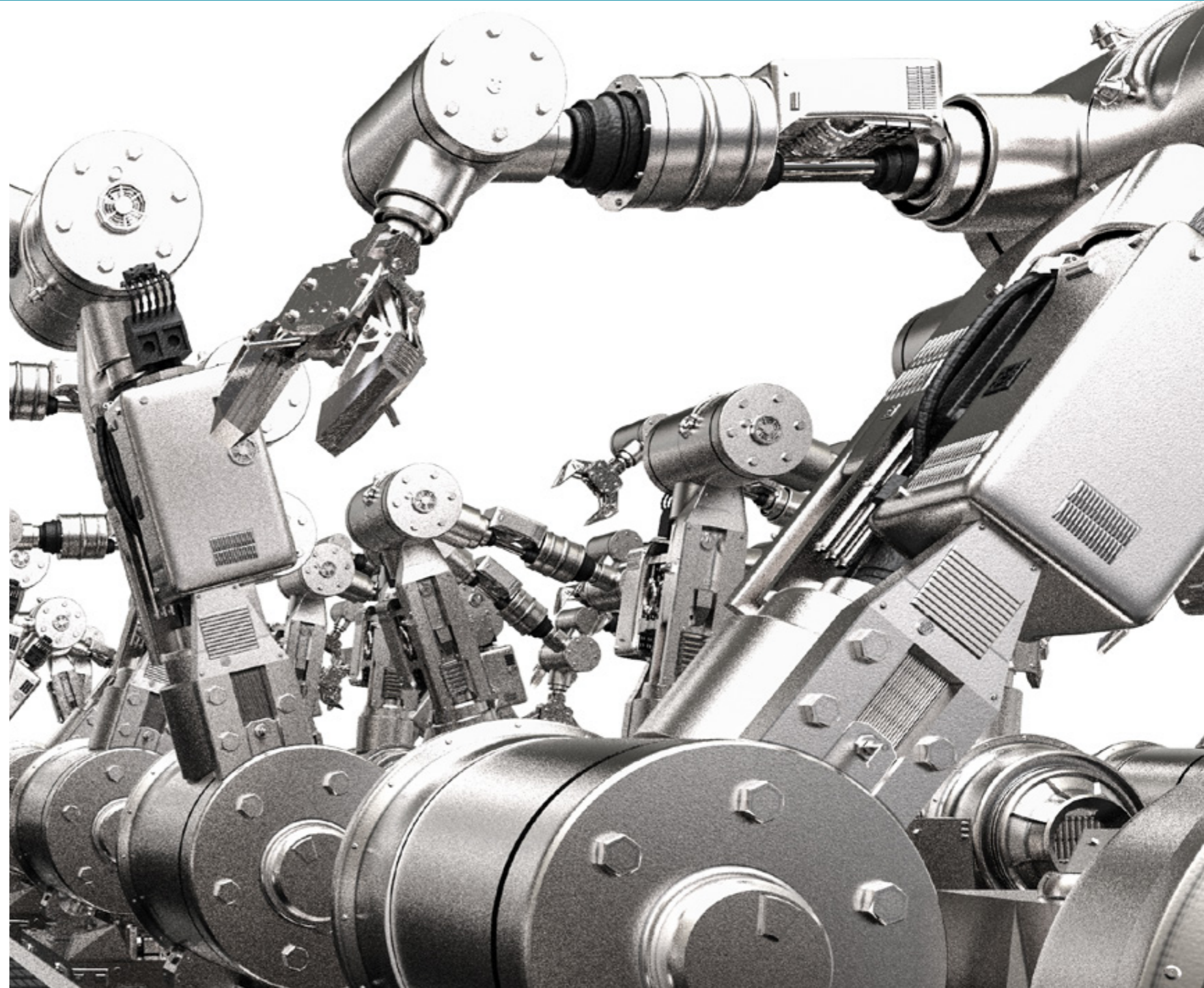

Our thanks go out to....

FOR HELPING WITH THE CREATION OF A GUIDE TO **ROBOTICS AND AUTOMATION**, WE EXTEND OUR **THANKS** TO THE FOLLOWING PEOPLE AND ORGANIZATIONS:

Matthias Heutger – Deutsche Post DHL Group

The Media Relations team at Trumpf GmbH

The Technology PR and Communications team at Ocado Technology

The Marketing Team at Medineering GmbH

Publitek

The Marketing Team at Distrelec

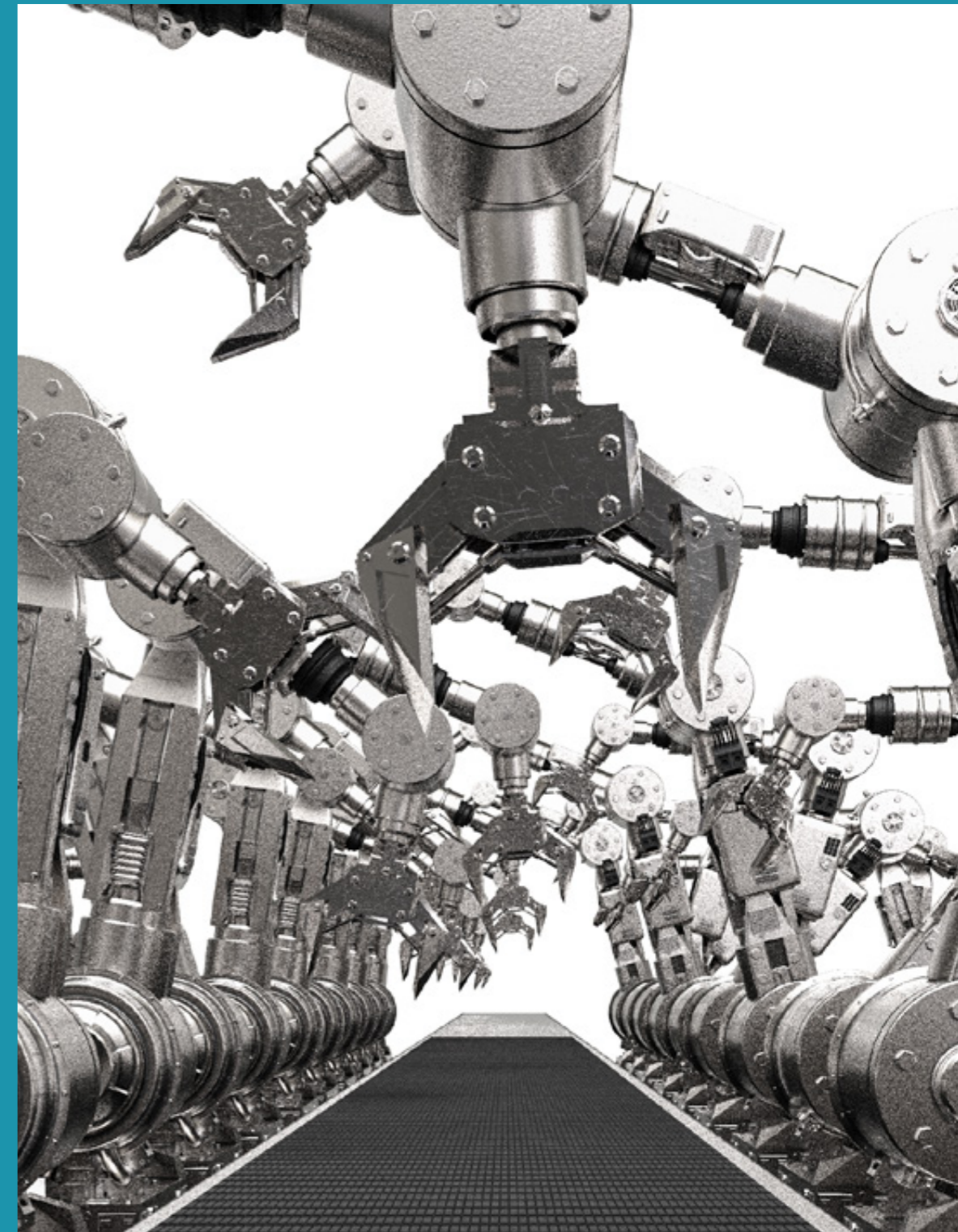



www.distrelec.de